



**TRIMAR**  
*Sedie e Tavoli*

2017 / 2018







*Sedie e Tavoli*

# Catalogo Prodotti 2017/2018

Azienda	4
Note tecniche	6

# INDICE

## ALLUMINIO

### HOTEL BAR RISTORANTE DEHOR

Sedie	10-12, 14-15
Poltrone	8-10, 13
Sgabelli	14
Tavoli	16-20
Basi	17-20



### MEETING

Poltrone	21-22
----------	-------



## ACCIAIO

### GIARDINO E DEHOR

Poltrone/Sedie	23
Tavoli	24
Divanetti	25
Articoli vari	25



### IMPIANTI SPORTIVI

Panche	26-29
Panchelli	26-29



### BAR RISTORANTI PIZZERIE CATERING COLLETTIVITÀ

Sedie	30-39 45-46, 48-49 55-60
Poltrone	47 50-54



### BAR RISTORANTI PIZZERIE

Sgabelli	40-44
----------	-------



### CATERING E SCUOLA

Sedie	59 61-63
-------	-------------



### BAR RISTORANTI PIZZERIE COLLETTIVITÀ

Sedie	64, 66-68
Poltrone	65



## ACCIAIO

### COLLETTIVITÀ

Sedie	68-70 73-75
Poltrone	71-72
Panche su trave	76-77
Moduli mensa	77
Separè	78
Appendiabiti	78



## TAVOLI

### BAR RISTORANTI PIZZERIE COLLETTIVITÀ

Tavoli e basi	80-106
---------------	--------



### CATERING COLLETTIVITÀ

Tavoli e basi	107-109
---------------	---------



## SEDIE E TAVOLI IN LEGNO

110

## CAMPIONARIO RICAMBI ED ACCESSORI

Ricambi e accessori per sedie e tavoli	112-113
Colori vernici in polvere	114
Colori dei tessuti	
Finta pelle (sky) normale	115
Tessuti normali	115
Tessuti serie ufficio	116
Tessuti ignifughi	116
Microfibra ignifuga	116
Finta pelle (skay) ignifuga	116
Tipologie e colori dei piani Verzalit, ecc.	117-118
Tipologie e colori delle sedute	119

## TAVOLI E SEDIE IN RESINA

Vasto assortimento tavoli e sedie in resina



# L'AZIENDA

L'azienda nasce nel 1982 ma si porta alle spalle un'esperienza professionale di quarant'anni.

La produzione è sin dall'inizio quella di sedie, tavoli e complementi di arredo in **ferro** e **alluminio** per diversi utilizzi: dal settore casa (interni ed esterni), ai locali pubblici (bar, ristoranti, pizzerie, alberghi, comunità, impianti sportivi, mense, dehor).

L'utilizzo dei nostri prodotti è di carattere **professionale**; le caratteristiche fondamentali sono la **robustezza**, la qualità dei materiali impiegati e la **durevolezza nel tempo**.

L'intero ciclo produttivo viene eseguito all'interno, seguendo le varie fasi di lavorazione, sino ad arrivare al prodotto finito.

**Punti di forza sono:**

- **Progettazione:** valutazione e ottimizzazione delle soluzioni più idonee
- **Flessibilità:** tempi di approntamento ridotti
- **Personalizzazione:** possibilità di coordinare i colori disponibili dei componenti (sedute per sedie e piani per tavoli) affinandoli ai relativi colori disponibili di serie e fuori serie e speciali delle strutture di sedie e tavoli
- **Su misura:** possibilità di produrre tavoli serie **Argentario** e **Delta** secondo le misure richieste

**Come si ordina il prodotto**

**Sedie:**

- 1 Indicare il nome della sedia
- 2 Indicare il tipo di seduta
- 3 Indicare il colore della seduta o l'eventuale copertura in tessuto/finta pelle e specificare se normale o ignifugo

**Tavoli:**

- 1 Indicare il nome del tavolo/base
- 2 Indicare tipo e colore della base
- 3 Indicare le dimensioni e lo spessore dell'eventuale piano, specificare il tipo di bordo

**Altri articoli:**

- 1 Indicare il nome dell'articolo
- 2 Indicare l'eventuale colore





Forgia



Magazzino



Macchina curvatubi cnc



Saldatura robotizzata



Reparto imbottiti

# NOTE TECNICHE

## VERNICIATURA CON POLVERI TERMOINDURENTI POLIESTERE

### COLORI STRUTTURE

<b>Di Serie</b>	Nero satinato (1)	Rosso ral 3000 (2)	Marrone (3)	Bianco (4)
<b>Fuori serie</b>	Blu elettrico (5)	Alluminio su ferro lucido (6)	Bordeaux (7)	Ossidato (8)
	Grigio grinzato opaco (9)	Giallo (10)	Grigio ral 7031 (11)	Canna di fucile (12)
	Martellato grigio (13)	Verde sequoia ral 6005 (16)	Nero goffrato (19)	Dorato opaco (20)
	Bucciato ramato (21)	Nero grinzato (22)	Antracite (24)	Panna/crema (25)
	Trasparente lucido su struttura grezza (26)		Trasparente opaco su struttura grezza (27)	
<b>Metallizzati cromo</b>	Cromo lucido con due passaggi di colore (23 LUC)	Cromo satinato (23 SAT)	Cromo opaco (23 OP)	

### PIANI

#### PIANO NOBILITATO ANTIGRAFFIO IDROFUGO

Con truciolare idrorepellente spessore 18 - 25 - 36 mm. Bordo Toro o ABS.

#### PIANO LAMINATO

Ottenuto con truciolare placcato e controplaccato in laminato plastico (PL), spessori 20 - 24 - 30 mm.

#### BORDATURE PIANI

Bordo in Gomma PVC nero Toro (BGT)

Bordo in Gomma PVC nero Piatto (BGP)

Bordo in ABS sp. 2 mm (ABS)

#### PIANO IGNIFUGO

Con truciolare ignifugo classe MI (P/IGN).

#### PIANO WERZALIT

Ottenuto ad alta pressione con superficie in laminato, disponibile in diverse colorazioni con caratteristiche idonee per l'utilizzo per esterni ed interni, antigraffio, resistente alle abrasioni e ad alte temperature.

Ciliegio (18W)	Verdino (40W)	Nero (33W)	Kbana rouge (43W)	Kbana taupe (44W)
Bianco (4W)	Avorio/Seringa (41W)	Palissade bois (42W)	Bounty (41W)	Palissade Blanc (45W)
Antracite (37W)	Wengè (31W)	Noce (39W)	Marmo Bianco (22 W)	
Travertino (25W)	Alu Solo (24 W)	Arancio (29W)	Rosso (34W)	

#### PIANO INOX

Incapsulato con lamiera Inox fiorettata (12WINOX).

Formati disponibili, Ø60\*, Ø70, Ø80, 60x60, 70x70, 80x80. Non idonei per esterni. Tempi di consegna 5 settimane.

\*Disponibile anche in Inox Satinato.

#### PIANO PLASTICA Ø55 (301)

Colori: bianco (4), marrone (2), aragosta (28), altri colori a richiesta.

#### PIANI MARMOVERO

Solo su richiesta.

#### PIANO MULTISTRATO PIOPPO GREZZI

Con o senza bordo in gomma (PMULT P.GR. ± BG.)

#### PIANO IN VETRO TEMPRATO

Sp. 10 mm, trasparente o satinato.

#### PIANO LAMINATO STRATIFICATO HPL

Sp. 12 mm, con bordo fresato semitoro.





# CINZIA LEGA

Telaio in tubo di lega alluminio Ø25 con doghe in alluminio.

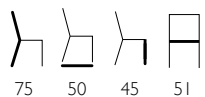

modello poltrona	modello seduta	colore seduta	colore telaio
907	400	-	Ossidato



modello poltrona	modello seduta	colore seduta	colore telaio
907	400	-	1



modello poltrona	modello seduta	colore seduta	colore telaio
907	400	-	16



modello poltrona	modello seduta	colore seduta	colore telaio
907	400	-	6

## CINZIA LEGA

Poltrona Alluminio	Verniciatura		
	serie	fuori serie	cromo
Con profili di alluminio VERN.COL. SERIE/FUORI SERIE	106,22	113,20	117,39
Con profili di alluminio OSSIDATA OPACA	135,56	-	-

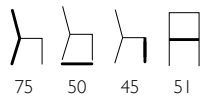

# CINZIA 2/3 LEGA

Telaio in tubo di lega alluminio Ø 25 mm.

modello poltrona	modello seduta	colore seduta	colore telaio
326 AL	454	arancio	9



modello poltrona	modello seduta	colore seduta	colore telaio
326 AL	447	nero	24



modello poltrona	modello seduta	colore seduta	colore telaio
326 AL	447	blu	6



modello poltrona	modello seduta	colore seduta	colore telaio
326 AL	454	nero	9



modello poltrona	modello seduta	colore seduta	colore telaio
326 AL	454	Verde	9

## CINZIA 2 LEGA (seduta rotonda) / CINZIA 3 LEGA (seduta sagomata a trapezio)

Sedile	Verniciatura		
	serie	fuori serie	cromo
Finta paglia a scatto tondo (colore paglia) con anello / sagomato a trapezio	81,31	88,30	92,49
Finta paglia a scatto tondo senza anello / sagomato a trapezio	81,31	88,30	92,49
Tex Plast Ø 40 a scatto	89,58	96,56	100,75
Scatto tondo/trap. (con anello col. Alluminio) / sagomato a trapezio	82,60	89,58	93,77
Scatto tondo imbottito in finta pelle	98,72	105,70	109,89
Scatto tondo imbottito in finta pelle ignifuga	105,62	112,6	116,79
Scatto tondo imbottito in tessuto	98,72	105,70	109,89
Scatto tondo imbottito in tessuto ignifugo	105,62	112,6	116,79
Finta paglia tondo con anello ignifugo Classe M1	86,9	93,88	98,07
Scatto sagomato a trapezio (con anello col. Alluminio)	82,60	89,58	93,77
Scatto sagomato a trapezio imbottito in finta pelle	96,43	103,41	107,6
Scatto sagomato a trapezio imbottito in finta pelle ignifuga	103,56	110,54	114,73
Scatto sagomato a trapezio imbottito in tessuto	96,43	103,41	107,6
Scatto sagomato a trapezio imbottito in tessuto ignifugo	99,99	106,97	111,16
Solo microfibra ignifuga	112,62	119,60	123,79
Finta paglia con anello ignifugo sagomato a trapezio Classe M1	83,85	90,83	95,02
<b>SOVRAPPREZZO</b>			
Struttura OSSIDATA OPACA	29,35	-	-

# ELISA - SEDIA

Telaio in tubo di lega con doghe in alluminio.

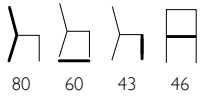

modello sedia	modello seduta	colore seduta	colore telaio
339	400	-	I



modello sedia	modello seduta	colore seduta	colore telaio
339	400	-	Ossidato

## ELISA SEDIA

Sedile	Ossidazione lucida	Verniciatura	
		serie	fuori serie
Con doghe di alluminio SEDIA OSSIDATA LUCIDA	76,23	89,57	95,56

# ELISA - POLTRONA

Telaio in tubo di lega con doghe in alluminio.

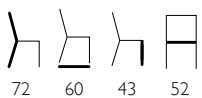

modello poltrona	modello seduta	colore seduta	colore telaio
340	400	-	Ossidato

## ELISA POLTRONA

Sedile	Ossidazione lucida	Verniciatura	
		serie	fuori serie
Con doghe di alluminio POLTRONA OSSIDATA LUCIDA	64,68	78,03	84,01

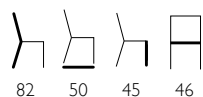

# JESSICA LEGA I

Telaio in tubo di lega di alluminio Ø 25 mm.

modello sedia	modello seduta	colore seduta	colore telaio
337	454	verde	Ossidato



modello sedia	modello seduta	colore seduta	colore telaio
337	454	blu	I



modello sedia	modello seduta	colore seduta	colore telaio
337	452/S.AN	-	6



modello sedia	modello seduta	colore seduta	colore telaio
337	452	-	24

## JESSICA LEGA I

Sedile	Verniciatura		
	serie	fuori serie	cromo
Finta paglia a scatto o NERO FIORE	76,87	83,85	88,04
Tex Plast Ø 40 a scatto	85,14	92,13	96,32
Vera paglia	97,83	104,81	109
Finta pelle	94,28	101,26	105,45
Tessuto	94,28	101,26	105,45
Tessuto ignifugo	101,18	108,16	112,35
Solo microfibra ignifuga	108,18	115,16	119,35
Finta paglia a scatto ignifugo Classe M1	82,46	89,44	93,63
Faggio Ø 40 cm sp.16 mm. + SCHIEN. FAGGIO Ø 35	128,58	135,56	139,75
Faggio multistrato [Ø 40 sp.16 mm.]	103,42	110,4	114,59
SOVRAPPREZZO			
Struttura OSSIDATA OPACA	29,35	-	-

# BISTROT SUPER LEGA

Telaio in tubo di lega di alluminio Ø 25 mm.

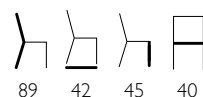

modello sedia	modello seduta	colore seduta	colore telaio
B325	452/S.AN	nero	ossidato

modello sedia	modello seduta	colore seduta	colore telaio
B325	452	-	I

## BISTROT SUPER LEGA

Sedile	Verniciatura		
	serie	fuori serie	cromo
Finta paglia a scatto o NERO FIORE	76,87	83,85	88,04
Tex Plast Ø 40 a scatto	85,14	92,13	96,32
Vera paglia	97,83	104,81	109,00
Finta pelle	94,28	101,26	105,45
Tessuto	94,28	101,26	105,45
Tessuto ignifugo	101,18	108,16	112,35
Solo microfibra ignifuga	108,18	115,16	119,35
Finta paglia a scatto ignifugo Classe M1	82,46	89,44	93,63
Faggio Ø 40 cm sp.16 mm.+ SCHIEN. FAGGIO Ø 35	128,58	135,56	139,75
Faggio multistrato [Ø 40 sp.16 mm]	103,42	110,4	114,59
Sedile Werzalit [Ø 40]	135,18	142,16	146,37
<b>SOVRAPPREZZO</b>			
Struttura OSSIDATA OPACA	29,35	-	-

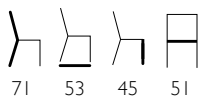

71 53 45 51

# BETTY LEGA - POLTRONA

Telaio in tubo di lega alluminio Ø 25 mm.



modello poltrona	modello seduta	colore seduta	colore telaio
328	XIL	bordeaux	ossidato



modello poltrona	modello seduta	colore seduta	colore telaio
328	XIL	blu	ossidato



modello poltrona	modello seduta	colore seduta	colore telaio
328	XIL	vimini	ossidato



modello poltrona	modello seduta	colore seduta	colore telaio
328	XIL	verde	ossidato

## BETTY LEGA - POLTRONA

Poltrona Alluminio	Verniciatura		
	serie	fuori serie	cromo
Xiloplast (Vimini, Bordeaux, Blu, Verde) TELAIO OSSIDATO LUCIDO	76,23	-	-

# FENICE - SEDIA

Struttura in lega di alluminio 25x25mm, interamente intrecciata.

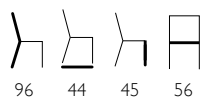

modello sedia	modello seduta	colore seduta	colore telaio
350	-	Antracite	-



modello sedia	modello seduta	colore seduta	colore telaio
350	-	Nocciola	-



## FENICE SEDIA

Poltrona Alluminio	Verniciatura serie
Intreccio Wiker Colori: Testa di Moro, Antracite, nocciola striato	139,76

# SGABELLO ALLUMINIO

Telaio in tubo di lega di alluminio Ø 28mm.

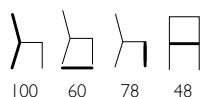

modello sgabello	modello seduta	colore seduta	colore telaio
390	400	-	ossidato

## SGABELLO ALLUMINIO

Sgabello Alluminio	Verniciatura serie
Struttura già assemblata	132,00
Struttura da assemblare con viti	115,50





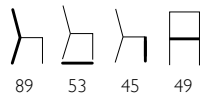

# RATTAN BISTROT - SEDIA

Struttura monoblocco polipropilene  
Disponibile nei colori: Antracite, Marrone e Juta.



modello sedia	colore
351	antracite

modello sedia	colore
351	marrone



modello sedia	colore
351	juta



Colori disponibili per  
RATTAN BISTROT SEDIA - POLTRONA



Antracite



Juta



Marrone



modello poltrona	colore
352	marrone

# RATTAN BISTROT - POLTRONA

Struttura monoblocco polipropilene  
Disponibile nei colori: Antracite, Marrone e Juta.

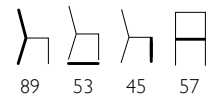

## RATTAN-BISTROT SEDIA/POLTRONA

Sedia e poltrona in polipropilene	
SEDIA Polipropilene nei colori ANTRACITE - MARRONE - JUTA PREZZO CAD PER QUANTITÀ MINIMA 22 PZ O MULTIPLI	52,00
POLTRONA Polipropilene nei colori ANTRACITE - MARRONE - JUTA PREZZO CAD PER QUANTITÀ MINIMA 20 PZ O MULTIPLI	56,00
SOVRAPPREZZO	
Per ordini inferiori alla quantità minima sovrapprezzo (min 4 pezzi)	7,00 cad

# TAVOLO RATTAN

Struttura monoblocco poliropilene.  
Disponibile nei colori: Antracite, Marrone e Juta.



90x90 75

Colori disponibili per  
TAVOLO RATTAN



Antracite Juta Marrone

modello tavolo	colore piano
353	antracite



## TAVOLO RATTAN

Tavolo in poliropilene	serie
Tavolo in poliropilene nei colori ANTRACITE - MARRONE - JUTA - 90x90 h 74,5 <b>PREZZO CAD PER QUANTITÀ MINIMA 12 PZ O MULTIPLI</b>	<b>95,00</b>
SOVRAPPREZZO	
Per ordini inferiori alla quantità minima	<b>10,00 cad</b>

# MONVISO

Gambe in alluminio.  
Piano in poliropilene.



70x70 72

Colori disponibili  
per MONVISO

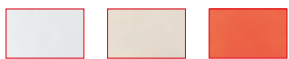

Bianco Avorio Arancio

Antracite Rosso Verde mela



modello tavolo	modello piano	colore piano	colore gambe
399	70x70	arancio	ossidato

## TAVOLO MONVISO

Tavolo in poliropilene	serie
Piano in poliropilene nei colori ARANCIO, AVORIO, ROSSO, VERDE MELA, ANTRACITE - 70x70 cm Gambe in Alluminio h 72 cm <b>PREZZO CAD PER QUANTITÀ MINIMA 30 PZ O MULTIPLI</b>	<b>85,00</b>
SOVRAPPREZZO	
Per ordini inferiori alla quantità minima	<b>10,00 cad</b>

# DECÒ LEGA I

Telaio in tubo di lega alluminio Ø 30 mm.  
Piedini neri. Smontabile.



modello tavolo	modello piano	colore piano	colore gambe
335-AL	werzalit Ø60	37VV antracite	6



modello base	colore gambe
335	9

Tavolo		Base	
Ø60	76	40 lato	73
Ø70		55 diag	
60x60			

## DECÒ LEGA I - TAVOLO

Piano	Verniciatura		
	serie	fuori serie	cromo
Werzalit normale [Ø 60 cm]	<b>146,74</b>	<b>153,74</b>	<b>157,93</b>
Werzalit normale [60X60 cm]	<b>159,32</b>	<b>166,31</b>	<b>170,50</b>
Werzalit normale [Ø 70 cm]	<b>159,32</b>	<b>166,31</b>	<b>170,50</b>
INOX FIORETT. [Ø 60 cm]	<b>165,43</b>	<b>172,41</b>	<b>176,62</b>
SOVRAPPREZZO			
Base OSSIDATA OPACA	<b>29,35</b>	-	-

## DECÒ LEGA I - GAMBE

Gambe	Verniciatura		
	serie	fuori serie	cromo
Per piani Ø60 - Ø70 - 60X60	<b>76,87</b>	<b>83,85</b>	<b>88,04</b>
SOVRAPPREZZO			
Base OSSIDATA	<b>29,35</b>	-	-



modello tavolo	modello piano	colore piano	colore gambe
335/2-AL	werzalit 70x70	31W wenghé	9

# DECÒ LEGA 2

Telaio in tubo di lega alluminio Ø 30 mm.  
Piedini neri. Smontabile.



modello base	colore gambe
336	24

Tavolo		Base	
Ø80	76	52 lato	73
70x70		72 diag	
80x80			

## DECÒ LEGA 2 - TAVOLO





Piano	Verniciatura		
	serie	fuori serie	cromo
Werzalit normale [70X70 cm]	<b>198,45</b>	<b>205,44</b>	<b>209,64</b>
INOX FIORETTATO [70X70 cm]	<b>207,37</b>	<b>217,82</b>	<b>218,55</b>
Werzalit normale [Ø 80 cm]	<b>180,28</b>	<b>187,28</b>	<b>191,47</b>
INOX FIORETTATO [Ø 80 cm]	<b>224,70</b>	<b>231,68</b>	<b>235,87</b>
Werzalit normale* [80X80 cm]	<b>218,02</b>	<b>225,01</b>	<b>229,20</b>
INOX FIORETTATO* [80X80 cm]	<b>225,27</b>	<b>232,25</b>	<b>236,46</b>
SOVRAPPREZZO			
Base OSSIDATA OPACA	<b>29,35</b>	-	-

## DECÒ LEGA 2 - GAMBE

Gambe	Verniciatura		
	serie	fuori serie	cromo
Per piani Ø80 - 70X70 - 80X80 max	<b>92,24</b>	<b>99,23</b>	<b>103,42</b>
SOVRAPPREZZO			
Base OSSIDATA	<b>29,35</b>	-	-

# CORSICA 3

Stelo in tubo di lega alluminio Ø 60 mm.  
Base ghisa ricoperta INOX lucido.  
Crociera in pressofusione di ghisa.

Tavolo		Base	
			
Ø60	74	51 lato	71
Ø70		51 diag	
60x60			

## CORSICA 3 - TAVOLO

Piano	Verniciatura
	serie
Werzalit normale [60x60 cm]	<b>180,63</b>
INOX FIORETTATO [60x60 cm]	<b>190,55</b>
Werzalit normale [Ø 60 cm]	<b>168,06</b>
INOX FIORETTATO [Ø 60 cm]	<b>192,51</b>
Werzalit normale [Ø 70 cm]	<b>178,32</b>
INOX FIORETTATO [Ø 70 cm]	<b>210,99</b>
SOVRAPPREZZO	
Stelo FAST FOOD - h 110 cm	<b>19,64</b>

## CORSICA 3 - BASE

Base	Verniciatura
	serie
Per piani Ø60 - 60X60 - 70X70 - 80X80 con 4 piedi	<b>98,18</b>
SOVRAPPREZZO	
Sistema piano Ribaltabile	<b>59,97</b>
Stelo FAST FOOD - h 108 cm	<b>19,64</b>







modello base	colore base
952/3-AL	9

modello base	modello piano	colore piano	colore base
952/3-AL	werzalit Ø60	29VV arancio	9

# CORSICA 4

Stelo in tubo di lega alluminio Ø 60 mm.  
Base ghisa ricoperta INOX lucido.  
Crociera in pressofusione di ghisa.

Tavolo		Base	
			
Ø80	74	45 lato	71
70x70		66 diag	
80x80			

## CORSICA 4 - TAVOLO

Piano	di serie
Werzalit normale [70X70 cm]	<b>222,08</b>
INOX FIORETTATO [70X70 cm]	<b>231,00</b>
Werzalit normale [Ø 80 cm]	<b>203,92</b>
INOX FIORETTATO [Ø 80 cm]	<b>248,33</b>
Werzalit normale [80X80 cm] (No ristorazione)	<b>241,65</b>
INOX FIORETTATO [80X80 cm] (No ristorazione)	<b>248,91</b>

## CORSICA 4 - BASE

Base	Verniciatura		
	serie	fuori serie	chromo
Per piani 60X60 - 70X70 - 80X80 con 4 piedi	<b>115,50</b>	-	-
SOVRAPPREZZO			
Sistema piano Ribaltabile	<b>59,97</b>		
Stelo FAST FOOD - h 108 cm	<b>19,64</b>		



modello base	modello piano	colore piano	colore base
952/4-AL	werzalit 70x70	37VV antracite	INOX

modello base	colore base
952/4-AL	INOX

# OSTUNI LEGA

Telaio in tubo di lega alluminio ovale 36X18 mm.  
Piedini neri. Smontabile.



Tavolo		Base	
Ø60	76	40 lato	73
Ø70		56 diag	
60x60			

## OSTUNI LEGA - TAVOLO

Piano	Verniciatura		
	serie	fuori serie	cromo
Werzalit normale [Ø 60 cm]	126,90	133,88	138,07
Werzalit normale [60X60 cm]	139,48	146,47	150,66
Werzalit normale [Ø 70 cm]	139,48	146,47	150,66
INOX FIORETT. [Ø 60 cm]	145,59	152,57	156,76
SOVRAPPREZZO			
Base OSSIDATA OPACA	29,35	-	-

## OSTUNI LEGA - GAMBE

Gambe	Verniciatura		
	serie	fuori serie	cromo
Per piani Ø60 - Ø70 - 60X60	57,20	64,19	66,18
SOVRAPPREZZO			
Base OSSIDATA	29,35	-	-

modello base	modello piano	colore piano	colore gambe
949-AL	werzalit Ø60	43W kbana rouge	6

modello base	colore gambe
949-AL	9

# OLIMPIA LEGA SUPER

Telaio in tubo di lega alluminio ovale 50X25 mm.  
Piedini neri. Smontabile.

Tavolo		Base	
Ø90	76	56 lato	73
Ø120		80 diag	
70x70			
80x80			
90x90			
80x120			



## OLIMPIA LEGA SUPER - TAVOLO

Piano	Verniciatura		
	serie	fuori serie	cromo
Werzalit normale [70X70 cm]	221,53	228,51	232,71
Werzalit normale [80X80 cm]	241,10	248,08	252,27
Werzalit normale [Ø 90 cm]	236,91	243,89	248,08
Werzalit normale [Ø 120 cm]	291,50	298,49	302,68
Werzalit normale [80X120 cm]	280,24	287,22	291,41
Werzalit normale [90X90 cm]	302,59	309,57	313,76
INOX FIORETTATO [70X70 cm]	230,45	237,44	241,63
INOX FIORETTATO [80X80 cm]	248,36	255,34	259,53
Piano stratificato 80X80 bicolore (noce/wenghé)	349,80	356,79	360,98
SOVRAPPREZZO			
Base OSSIDATA OPACA	29,35	-	-

## OLIMPIA LEGA SUPER - GAMBE

Gambe	Verniciatura		
	serie	fuori serie	cromo
Per piani 70X70 INOX - 80X80 - Ø90 - Ø120 - 80X120	115,50	122,49	126,68
SOVRAPPREZZO			
Base OSSIDATA	29,35	-	-





modello base	colore gambe
354-AL	1

modello base	modello piano	colore piano	colore gambe
354-AL	HPL 80x80	castagno	9

# MONACO LEGA

Telaio in tubo di lega alluminio Ø30.

Piedini neri. Smontabile.

Tavolo		Base	
			
Ø55	50/72	68 lato	48/70
Ø60	72	68 lato	70
60x60	72	60 lato	70
70x70	72	70 lato	70

modello tavolo	modello piano	colore piano	colore gambe
334-AL	werzalit Ø60	33W	9

## MONACO LEGA - TAVOLO

Piano	Verniciatura		
	serie	fuori serie	cromo
Werzalit normale [Ø 60 cm]	<b>122,98</b>	<b>129,98</b>	<b>134,17</b>
INOX FIORETT. [Ø 60 cm]	<b>141,67</b>	<b>148,67</b>	<b>152,86</b>
Tavolo Monaco Lega 4 gambe 60x60	<b>176,87</b>	<b>183,85</b>	<b>194,65</b>
Tavolo Monaco Lega 4 gambe 70x70	<b>176,87</b>	<b>183,85</b>	<b>194,65</b>
SOVRAPPREZZO			
Base OSSIDATA OPACA	<b>29,35</b>	-	-

## MONACO LEGA - GAMBE

Gambe	Verniciatura		
	serie	fuori serie	cromo
Per piani Ø60 - 60X60	<b>53,11</b>	<b>67,08</b>	<b>74,07</b>
Per piani 60x60 o 70X70, 4 gambe	<b>70,84</b>	<b>77,83</b>	<b>82,02</b>
SOVRAPPREZZO			
Base OSSIDATA	<b>29,35</b>	-	-







modello base	colore gambe
334-AL	1

modello tavolo	modello piano	colore piano	colore gambe
334-AL-4g	werzalit 60x60	37W	nero

# ARGENTARIO LEGA

Telaio in tubo alluminio.

Gambe tubo quadro 40x40 mm. Smontabile.

Tavolo		Base	
			
70x70	76	63x73	74
80x80		73x73	
90x90		83x83	
70x110		63x103	
80x120		73x113	

## ARGENTARIO LEGA - TAVOLO

Piano	Verniciatura		
	serie	fuori serie	cromo
Werzalit normale [80x80]	<b>248,03</b>	<b>255,01</b>	<b>259,20</b>
Werzalit normale [90x90]	<b>313,59</b>	<b>320,57</b>	<b>324,76</b>
Werzalit normale [70x110]	<b>271,67</b>	<b>278,65</b>	<b>282,84</b>
Werzalit normale [80x120]	<b>296,74</b>	<b>303,72</b>	<b>307,91</b>

## ARGENTARIO LEGA - GAMBE

Base ARGENTARIO LEGA	Misure cm per piano	Verniciatura		
		serie	fuori serie	cromo
Gamba 40X40 ALLUMINIO	80X80	<b>122,43</b>	<b>129,42</b>	<b>133,61</b>
	90X90	<b>126,50</b>	<b>133,49</b>	<b>137,68</b>
	70X110	<b>126,50</b>	<b>133,49</b>	<b>137,68</b>
	80X120	<b>132,00</b>	<b>138,99</b>	<b>143,18</b>

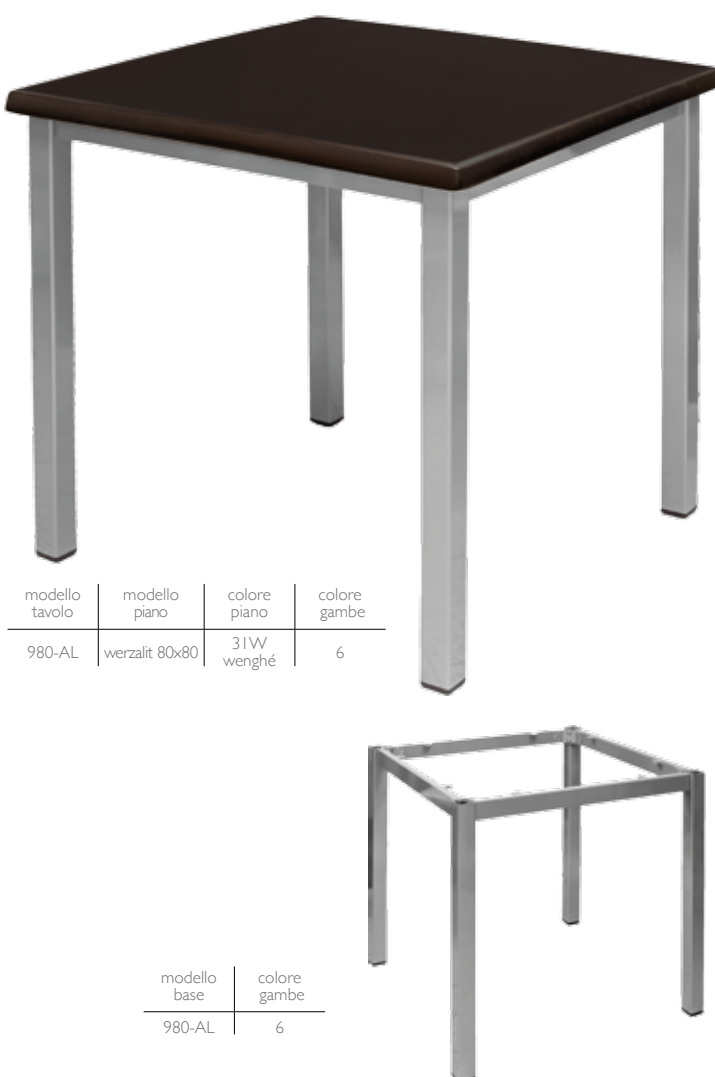

modello tavolo	modello piano	colore piano	colore gambe
980-AL	werzalit 80x80	31W wenghé	6

modello base	colore gambe
980-AL	6

# MINERVA LEGA

Telaio in tubo di lega alluminio 25X25 mm.  
Predisposto con fori fissaggio braccio, tavoletta, ganci o braccioli.

## MINERVA LEGA SEDIA

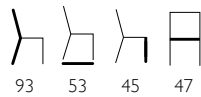

modello sedia	modello seduta	colore seduta	colore telaio
302	500	verde scuro	ossidato



modello sedia	modello seduta	colore seduta	colore telaio
302	500	blu chiaro	ossidato



modello sedia	modello seduta	colore seduta	colore telaio
302	500	verde chiaro	ossidato



modello sedia	modello seduta	colore seduta	colore telaio
302	500	blu scuro	ossidato



modello sedia	modello seduta	colore seduta	colore telaio
302	500	rosso	6



## MINERVA LEGA POLTRONA

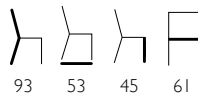

modello poltrona	modello seduta	colore seduta	colore telaio
302-POL	500	bordeaux	20



modello sedia	modello seduta	colore seduta	colore telaio
302	500	nero	ossidato

## MINERVA LEGA - SEDIA

Sedia	Verniciatura		
	serie	fuori serie	cromo
Tessuto ignifugo	183,44	190,42	194,62
Microfibra ignifuga	190,77	197,76	201,95
SOVRAPPREZZI			
Coppia di ganci pressofusi con fori	13,98	20,97	25,16
Bracciolo imbottito SMONTABILE/CAD.	40,52	47,52	51,71
Bracciolo non imb.+ tavoletta plastica nera, sfilabile. antipanico + piastra attacco	69,88	76,87	81,06
Bracciolo non imb.+ tavoletta laminato., sfilabile. antipanico + piastra attacco	72,68	114,31	83,85
Struttura OSSIDATA OPACA (solo sedia)	29,35	-	-
Bracciolo OSSIDATO OPACO	8,38	-	-
DISTANZIALE AGGANCIAMENTO (soluz. con tavoletta)	27,95	34,94	39,13

## MINERVA LEGA - POLTRONA

Poltrona	Verniciatura		
	serie	fuori serie	cromo
Microfibra ignifuga BRACCIOLI IMBOTTITI	249,47	256,45	260,65



# DITE I E 2

Telaio in tubo di lega di alluminio 22X22 mm. Predisposto con fori di fissaggio braccio tavoletta ganci o braccioli. Sovrapponibile 12 Pz.

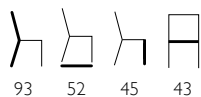

modello sedia	modello seduta	colore seduta	colore telaio
304	500-IGN	205	20



modello sedia	modello seduta	colore seduta	colore telaio
303	500	205	20

## DITE I - 2 LEGA

Sedia	Verniciatura
	serie
Tessuto ignifugo	305,00
<b>SOVRAPPREZZO</b>	
Microfibra ignifuga	13,00

modello	colore telaio
303-CARR	20



CARRELLO PORTA SEDIE

## CARRELLO PORTA SEDIE

Sedia	Verniciatura		
	serie	fuori serie	cromo
Dimensione carrello 61x56 cm	134,17	141,16	145,35

## FODERA PER DITE I E 2

modello	colore
303-FOD	Bianco



## FODERA PER SEDIA DITE I - 2 LEGA

Fodera	serie
Fodera in tessuto bianco 160 g/m <sup>2</sup>	49,50



# CAPRI

Telaio in tondino di acciaio pieno. Sovrapponibile.

Zincatura a caldo ad immersione.

Fornito sia zincato grezzo che verniciato con polveri poliestere.

## CAPRI POLTRONA

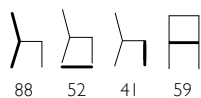

modello poltrona	colore telaio
712	16



modello poltrona	colore telaio
712	zincato grezzo

## CAPRI SEDIA

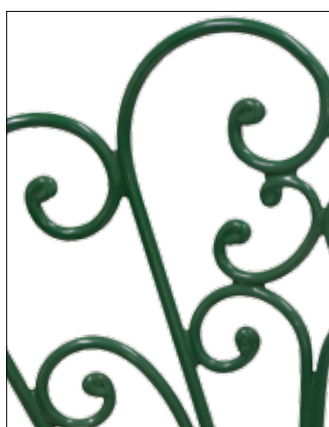
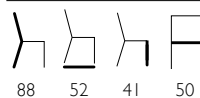

modello sedia	colore telaio
711	4



modello sedia	colore telaio
711	24

## CAPRI POLTRONA - CAPRI SEDIA

Sedile	Verniciatura		
	grezzo	zincato grezzo	zincato verniciato
Sedile in lamiera forata	97,61	163,25	173,25*

\* verniciatura in tutti i colori escluso metallizzato cromo lucido e satinato



# CAPRI - TAVOLO

Telaio in tondino di acciaio pieno. Sovrapponibile.

Zincatura a caldo ad immersione.

Fornito sia zincato grezzo che verniciato con polveri poliesteri.

Disponibile nei formati: tondi Ø60cm - 80cm - 100cm  
rettangolari 70x120 cm - 60x100 cm

  
 Ø60 71  
 Ø80  
 Ø100  
 60x100  
 70x120



modello tavolo	modello piano	colore telaio
713	Ø100 (283)	4



modello tavolo	modello piano	colore telaio
713	Ø60 (281)	4



modello tavolo	modello piano	colore telaio
713	70x120 (286)	zincato grezzo

modello tavolo	modello piano
713	Ø60 (281)
	Ø80 (282)
	Ø100 (283)
	60x100 (284)
	70x120 (285)

\* verniciatura in tutti i colori escluso metallizzato cromo lucido e satinato

## CAPRI - TAVOLO

Piano	Verniciatura		
	grezzo	zincato grezzo	zincato verniciato
Piano lamiera forata [Ø60 cm]	140,66	221,00	231,00*
Piano lamiera forata [Ø80 cm]	177,55	267,20	277,20*
Piano lamiera forata [Ø100 cm]	248,27	342,28	352,28*
Piano lamiera forata [60x100 cm]	252,88	348,05	358,05*
Piano lamiera forata [70x120 cm]	328,21	446,23	456,23*



# CAPRI - DIVANETTO

Telaio in tondino di acciaio pieno. Sovrapponibile.

Zincatura a caldo ad immersione.

Fornito sia zincato grezzo che verniciato con polveri poliestere.

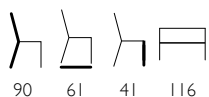

modello	colore telaio
723	4

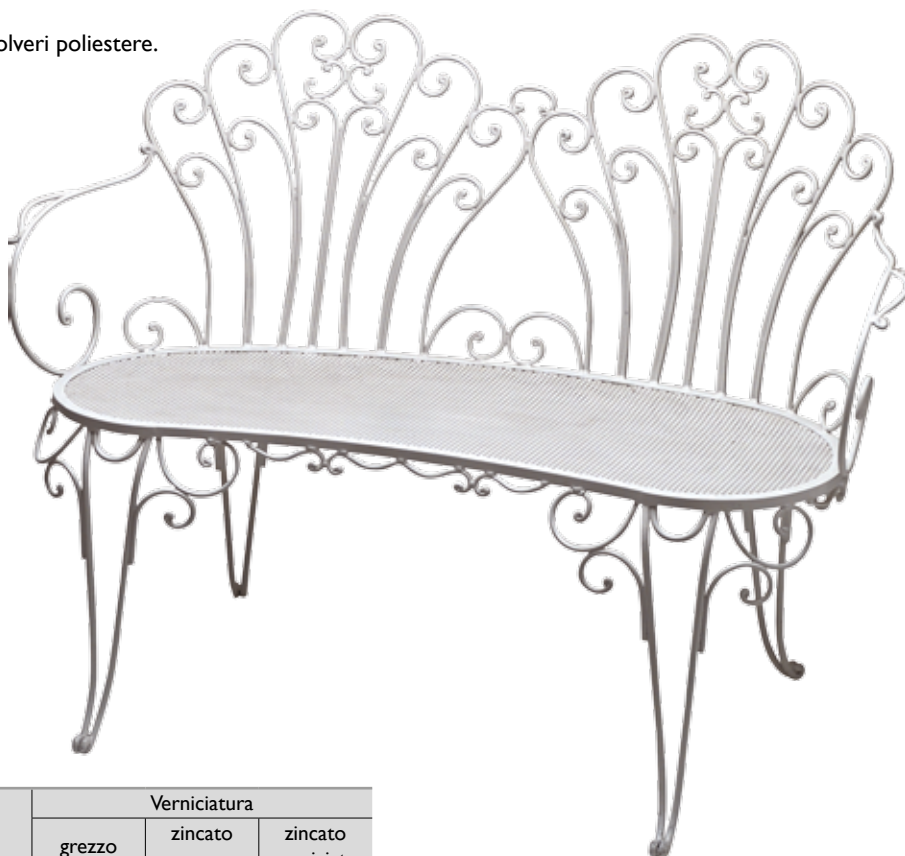

## CAPRI - DIVANETTO

Sedile	Verniciatura		
	grezzo	zincato grezzo	zincato verniciato
Sedile in lamiera forata	230,97	331,50	346,50*

# CAPRI - FIORIERA

Telaio in tondino di acciaio pieno. Sovrapponibile.

Zincatura a caldo ad immersione.

Fornito sia zincato grezzo che verniciato con polveri poliestere.

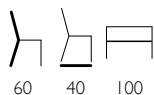

## CAPRI - FIORIERA

Vaschetta	Verniciatura		
	grezzo	zincato grezzo	zincato verniciato
Vaschetta in lamiera zincata	123,75	192,13	202,13*

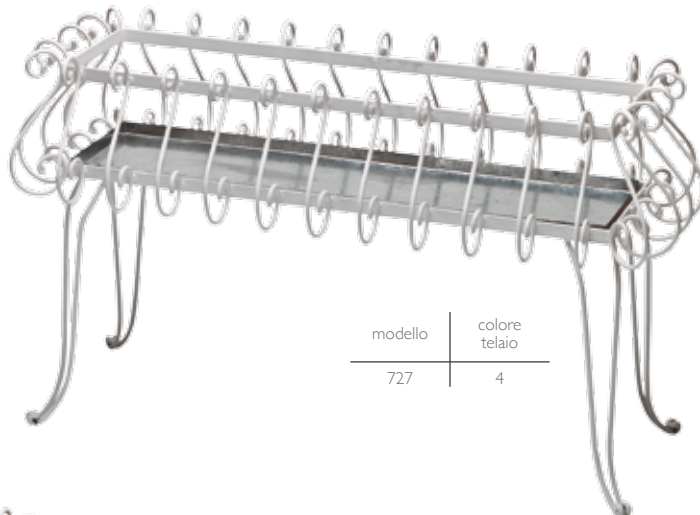

modello	colore telaio
727	4

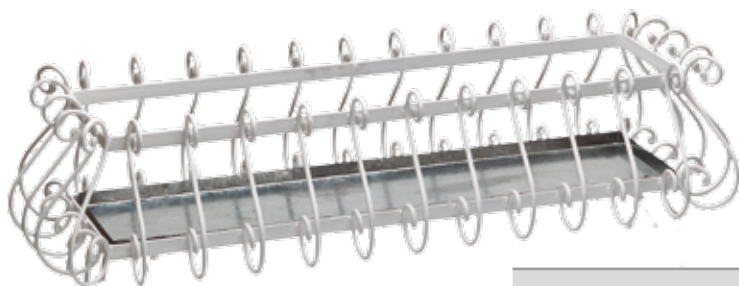

modello	colore telaio
727 A MURO	4

## CAPRI - FIORIERA A MURO

Vaschetta	Verniciatura		
	grezzo	zincato grezzo	zincato verniciato
Predisposta con attacchi per tasselli a muro	95,86	165,16	175,16*
<b>SOVRAPPREZZO</b>			
Staffe per fissaggio a ringhiera	23,07		

\* verniciatura in tutti i colori escluso metallizzato cromo lucido e satinato

# BORA 1/2 - PANCA

Struttura in acciaio.

Seduta e schienale in tubolare 40X15 mm.

Smontabile.

BORA 2 PANCA: Zincata a caldo.



80 51 120-150



## BORA 1 - PANCA

Panca	Verniciatura		
	serie	fuori serie	cromo
120 cm	167,71	174,69	178,88
150 cm	184,48	191,47	195,66
Coppia gambe panca	79,66	86,65	90,84

## BORA 2 - PANCA ZINCATA A CALDO

Panca	Verniciatura		
	zincato grezzo	serie	fuori serie
120 cm	219,78	223,61	230,59
150 cm	243,54	247,37	254,35

modello panca	modello seduta	colore seduta	colore telaio
511	BORA	verde	16

# BORA 1/2 - PANCHELLO

Struttura in acciaio.

Seduta in tubolare 40X15 mm.

Smontabile.

BORA 2 PANCHELLO: Zincato a caldo.



45 37 120-150



modello panca	modello seduta	colore seduta	colore telaio
504	BORA	verde	16

## BORA 1 - PANCHELLO

Panca	Verniciatura		
	serie	fuori serie	cromo
120 cm	121,58	128,58	132,77
150 cm	134,17	141,15	145,34
Coppia gambe panchello	60,09	67,08	71,28

## BORA 2 - PANCHELLO ZINCATO A CALDO

Panca	Verniciatura		
	zincato grezzo	serie	fuori serie
120 cm	160,72	161,90	168,87
150 cm	185,88	187,05	194,04

# GIADA I - PANCA

Gambe in acciaio verniciate polveri poliestere.  
Seduta e schienale in doghe di legno  
spessore 30 mm trattato con impregnante.  
Smontabile.



80 51 120-150



modello panca	modello seduta	colore seduta	colore telaio
520	524	con impregnante	zincato grezzo

modello panca	modello seduta	colore seduta	colore telaio
520	524	con impregnante	I



## GIADA I - PANCA

Panca	Verniciatura		
	serie	fuori serie	cromo
Piano legno abete naturale 120 cm	209,64	216,62	220,80
Piano legno abete naturale 150 cm	227,80	234,78	238,97
Coppia gambe panca	79,66	86,65	90,84

# GIADA I - PANCHELLO

Gambe in acciaio verniciato polveri poliestere.  
Seduta e schienale in doghe di legno  
spessore 30 mm trattato con impregnante.  
Smontabile.



45 37 120-150

modello panca	modello seduta	colore seduta	colore telaio
525	524	con impregnante	4



## GIADA - PANCHELLO

Panca	Verniciatura		
	serie	fuori serie	cromo
Piano legno abete naturale 120 cm	136,96	143,95	148,14
Piano legno abete naturale 150 cm	146,74	153,74	157,92
Coppia gambe panchello	60,09	67,08	71,28

# VALENTINA - PANCA

Gambe in acciaio. Seduta e schienale in profili di resina antiurto bianchi. Smontabile.



80 51 120-150

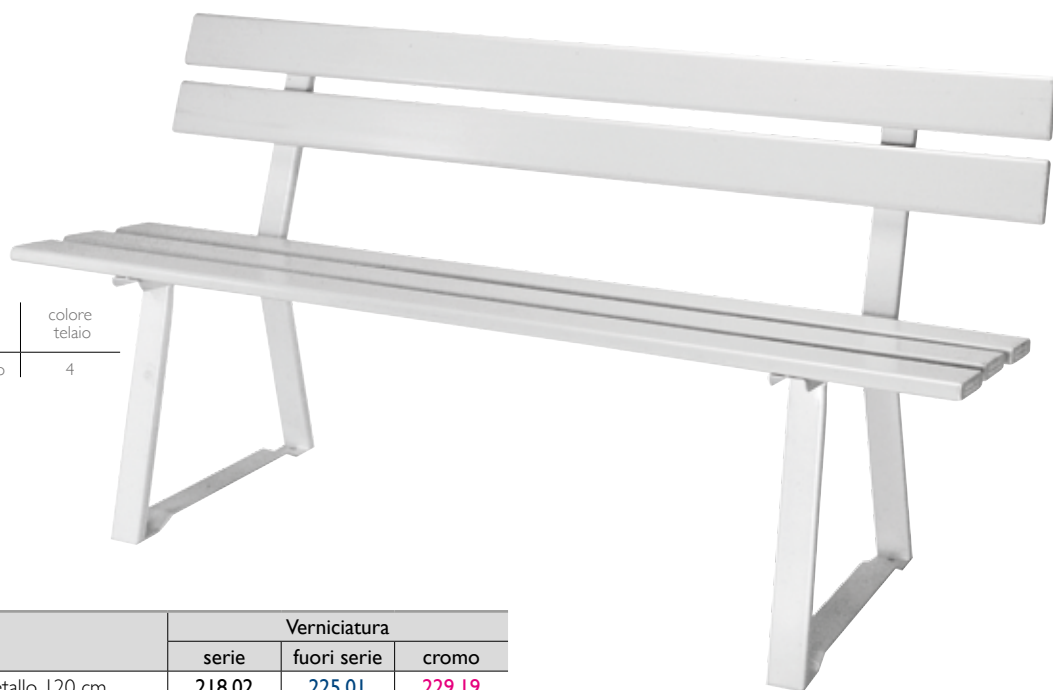

modello panca	modello seduta	colore seduta	colore telaio
515	522	solo bianco	4

## VALENTINA - PANCA

Panca	Verniciatura		
	serie	fuori serie	cromo
Piano doghe resina antiurto con anima metallo 120 cm	218,02	225,01	229,19
Piano doghe resina antiurto con anima metallo 150 cm	241,78	248,77	252,94
Coppia gambe panca	79,66	86,65	90,84

# VALENTINA - PANCHELLO

Gambe in acciaio verniciate polveri poliestere. Seduta con profili in resina antiurto bianchi. Smontabile.

modello panca	modello seduta	colore seduta	colore telaio
513	522	solo bianco	4



45 37 120-150



## VALENTINA - PANCHELLO

Panca	Verniciatura		
	serie	fuori serie	cromo
Piano doghe resina antiurto con anima metallo 120 cm	132,77	139,76	143,94
Piano doghe resina antiurto con anima metallo 150 cm	142,55	149,53	153,72
Coppia gambe panchello	60,09	67,08	71,28

## COPPIA GAMBE PANCA /PANCHELLO PER BORA, GIADA , VALENTINA

Panca	Verniciatura		
	serie	fuori serie	cromo
Coppia gambe panchello	60,09	67,08	71,28
Coppia gambe panca	79,66	86,65	90,84



modello colore  
776 1



modello colore  
777 zincato grezzo

# PALESTRA GIADA/BORA

Struttura in acciaio verniciato.

Sedute in doghe di legno trattato con impregnante, o tubolare 40x15.

Smontabile.

Doppia fila ganci append. (met.-plast.) + versione a parete.



185 74 120-150



modello panca	modello seduta	colore seduta	colore telaio
716	523	con impregnante	4

## PALESTRA GIADA - PANCA

Panca	Verniciatura		
	serie	fuori serie	cromo
Piano legno abete + N.2 FILE G.APP.MET.X6G. (GIADA) [74X120]	483,55	490,55	494,74
Piano legno abete + N.2 FILE G.APP.MET.X7G. (GIADA) [74X150]	568,80	575,80	579,99
Con aggiunta porta borse [74X120]	620,51	627,50	631,70
Con aggiunta porta borse [74X150]	715,55	722,54	726,73

## PALESTRA BORA - PANCA

Panca	Verniciatura		
	serie	fuori serie	cromo
Piano ferro + N.2 FILE G.APP.MET.X6G. (BORA) [74X120]	461,20	468,18	472,37
Piano ferro + N.2 FILE G.APP.MET.X7G. (BORA) [74X150]	472,37	479,36	483,55
Con aggiunta porta borse [74X120]	514,29	521,29	525,48
Con aggiunta porta borse [74X150]	606,54	613,53	617,72

**NOTA:** Per versione singola a parete prezzi sopra indicati da dividere a metà

**NOTA:** Su richiesta possono essere montati i ganci appendiabiti in plastisca neri (per il tipo di ganci vedi: Posto appendiabiti a muro su barra tubolare)

# BIRRERIA

Gambe in acciaio plastificate o verniciate.

Seduta con profili in resina antiurto bianchi. Smontabile.

## Panchello Pieghevole



45 25 220



modello panca	modello seduta	colore seduta	colore telaio
155	526	naturale	1

## Tavolo Pieghevole

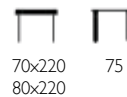

70x220 75  
80x220



modello base	modello piano	colore piano	colore gambe
-	525	naturale	16



## BIRRERIA - PANCHELLO PIEGHEVOLE

Panca	Verniciatura
	serie
Seduta legno abete naturale 220x25 cm	72,60

## BIRRERIA - TAVOLO PIEGHEVOLE

Tavolo	Verniciatura
	serie
Piano legno abete naturale 70x220	198,00
Piano legno abete naturale 80x220	209,00

# BISTROT Ø22

Telaio in tubo di acciaio Ø 22 mm.  
Piedini neri. Sovrapponibile.

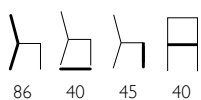

modello sedia	modello seduta	colore seduta	colore telaio
911	452	paglia-nero	1



modello sedia	modello seduta	colore seduta	colore telaio
911	452	paglia-marrone	25



modello sedia	modello seduta	colore seduta	colore telaio
911	Tex Plast	metallizzato	24

## BISTROT Ø 22 - SEDIA

Sedile	Verniciatura		
	serie	fuori serie	cromo
Finta paglia a scatto o fiore	44,73	51,71	55,90
Tex Plast Ø 40 a scatto	53,00	59,98	64,17
Vera paglia	65,69	72,67	76,86
Finta pelle	62,14	69,12	73,31
Tessuto	62,14	69,12	73,31
Tessuto ignifugo Classe M1	69,04	76,02	80,21
Solo microfibra ignifuga	76,04	83,02	87,21
Finta paglia a scatto ignifugo Classe M1	50,32	57,3	61,49
Solo tessuto ignifugo	65,59	72,57	76,76
Solo Skay ignifugo	65,59	72,57	76,76
Faggio [Ø40 sp. 16 mm]	71,28	78,26	82,45
SOVRAPPREZZO			
Cromatura	49,50		
Anello plastica grigio metallizzato	1,28		



modello sedia	modello seduta	colore seduta	colore telaio
911	452/S.AN.	blu	6



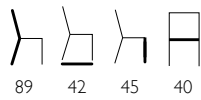

# BISTROT SUPER Ø25

Telaio in tubo di acciaio Ø 25 mm.  
Piedini neri. Sovrapponibile.



modello sedia	modello seduta	colore seduta	colore telaio
921	452/SAN.	nero	2



modello sedia	modello seduta	colore seduta	colore telaio
921	Tex Plast	grigio	9



modello sedia	modello seduta	colore seduta	colore telaio
921	452/SAN.	bianco	4



modello sedia	modello seduta	colore seduta	colore telaio
921	462	801	1

## BISTROT SUPER Ø 25 - SEDIA

Sedile	Verniciatura		
	serie	fuori serie	cromo
Finta paglia a scatto o fiore (kg 3,8)	47,52	54,51	58,70
Tex Plast Ø 40 a scatto	55,79	62,78	66,97
Vera paglia	68,48	75,46	79,65
Finta pelle	64,93	71,91	76,10
Tessuto	64,93	71,91	76,10
Tessuto ignifugo Classe M1	71,83	78,81	83,00
Solo microfibra ignifuga	78,83	85,81	90,00
Finta paglia a scatto ignifugo Classe M1	53,10	60,09	64,27
Solo tessuto ignifugo	68,38	75,36	79,55
Solo Skay ignifugo	68,38	75,36	79,55
Faggio [Ø40 sp. 16 mm]	74,07	81,05	85,24
SOVRAPPREZZO			
Cromatura	49,50		
Anello plastica grigio metallizzato	1,28		

# BISTROT COMFORT

Telaio in tubo di acciaio Ø 25 mm.

Piedini neri. Sovrapponibile.

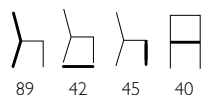

modello sedia	modello seduta	colore seduta	colore telaio
922	462	904 blu	I



modello sedia	modello seduta	colore seduta	colore telaio
922	462	102 nocciola	23 SAT



modello sedia	modello seduta	colore seduta	colore telaio
922	462	501 rosso	9



modello sedia	modello seduta	colore seduta	colore telaio
922	462	801 verde	6

## BISTROT COMFORT - SEDIA

Sedile e schienale	Verniciatura		
	serie	fuori serie	chromo
Finta pelle	90,84	97,83	102,03
Tessuto	90,84	97,83	102,03
Tessuto ignifugo Classe M1	124,38	131,37	135,56
Solo tessuto ignifugo	107,61	114,60	118,79
Solo microfibra ignifuga	122,61	129,60	133,79
Solo Skay ignifugo	114,60	121,58	125,79
SOVRAPPREZZO			
Anello plastica grigio metallizzato	1,28		

# BISTROT RICCIOLO

Telaio in tubo di acciaio Ø 25 mm.  
Piedini neri. Sovrapponibile.

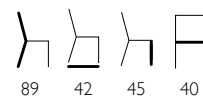

modello sedia	modello seduta	colore seduta	colore telaio
933	476	P97	22



modello sedia	modello seduta	colore seduta	colore telaio
933	452/S.AN.	metallizzato	6



modello sedia	modello seduta	colore seduta	colore telaio
933	462	801 verde	1

modello sedia	modello seduta	colore seduta	colore telaio
933	462/met	904 blu	6

## BISTROT RICCIOLO - SEDIA

Sedile	Verniciatura		
	serie	fuori serie	cromo
Finta paglia a scatto o fiore (kg 3,8)	62,90	69,88	74,07
Tex Plast Ø 40 a scatto	71,17	78,16	82,35
Vera paglia	83,86	90,84	95,03
Finta pelle	80,31	87,29	91,48
Tessuto	80,31	87,29	91,48
Tessuto ignifugo Classe M1	87,21	94,19	98,38
Finta paglia a scatto ignifugo Classe M1	68,49	75,47	79,66
Solo tessuto ignifugo	83,76	90,74	94,93
Solo microfibra ignifuga	90,76	97,74	101,93
Solo Skay ignifugo	83,76	90,74	94,93
Faggio [Ø40 sp. 16 mm]	89,45	96,43	100,62
SOVRAPPREZZO			
Anello plastica grigio metallizzato	1,28		

# NEW BISTROT I

Telaio in tubo di acciaio Ø 25 mm.  
Piedini neri. Sovrapponibile.

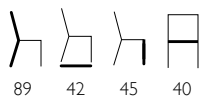

modello sedia	modello seduta	colore seduta	colore telaio
932	452/SAN	nero	I



modello sedia	modello seduta	colore seduta	colore telaio
932	452/SAN	nero	24



modello sedia	modello seduta	colore seduta	colore telaio
932	443	paglia	I



modello sedia	modello seduta	colore seduta	colore telaio
932	454	nero	I

## NEW BISTROT I - SEDIA

Sedile	Verniciatura		
	serie	fuori serie	chromo
Finta paglia a scatto o fiore	51,71	58,70	62,89
Tex Plast Ø 40 a scatto	59,98	66,97	71,16
Vera paglia	72,67	79,65	83,84
Finta pelle	69,12	76,10	80,29
Tessuto	69,12	76,10	80,29
Tessuto ignifugo Classe M1	76,02	83,00	87,19
Finta paglia a scatto ignifugo Classe M1	57,30	64,28	68,47
Solo tessuto ignifugo	72,57	79,55	83,74
Solo microfibra ignifuga	79,57	86,55	90,74
Solo Skay ignifugo	72,57	79,55	83,74
Faggio [Ø40 sp. 16 mm]	78,26	85,24	89,43
SOVRAPPREZZO			
Anello plastica grigio metallizzato	1,28		

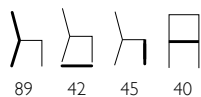

# NEW BISTROT 2

Telaio in tubo di acciaio Ø 25 mm.  
Piedini neri. Sovrapponibile.

modello sedia	modello seduta	colore seduta	colore telaio
909	462	(37) 904 blu	1



modello sedia	modello seduta	colore seduta	colore telaio
909	476	P87	23 LUC

modello sedia	modello seduta	colore seduta	colore telaio
909	476	P97	6



modello sedia	modello seduta	colore seduta	colore telaio
909	452/SAN.	nero	9

## NEW BISTROT 2 - SEDIA

Sedile	Verniciatura		
	serie	fuori serie	cromo
Finta paglia a scatto o fiore	51,71	58,70	62,89
Tex Plast Ø 40 a scatto	59,98	66,97	71,16
Vera paglia	72,67	79,65	83,84
Finta pelle	69,12	76,10	80,29
Tessuto	69,12	76,10	80,29
Tessuto ignifugo Classe M1	76,02	83,00	87,19
Finta paglia a scatto ignifugo Classe M1	57,30	64,28	68,47
Solo tessuto ignifugo	72,57	79,55	83,74
Solo microfibra ignifuga	79,57	86,55	90,74
Solo Skay ignifugo	72,57	79,55	83,74
Faggio [Ø40 sp. 16 mm]	78,26	85,24	89,43
<b>SOVRAPPREZZO</b>			
Anello plastica grigio metallizzato	1,28		

# ELENA

Telaio in tubo di acciaio Ø22 mm.  
Piedini neri. Sovrapponibile

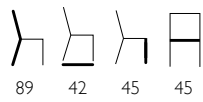

modello sedia	modello seduta	colore seduta	colore telaio
938	476	P01	9



modello sedia	modello seduta	colore seduta	colore telaio
938	452/S.AN.	grigio metallizzato	6



modello sedia	modello seduta	colore seduta	colore telaio
938	476	P87	6



modello sedia	modello seduta	colore seduta	colore telaio
938	476	P128	9

## ELENA - SEDIA

Sedile	Verniciatura		
	serie	fuori serie	cromo
Finta paglia a scatto o fiore	65,68	72,68	76,87
Tex Plast Ø 40 a scatto	73,95	80,94	85,14
Vera paglia	86,64	93,62	97,81
Finta pelle	83,09	90,07	94,26
Tessuto normale	83,09	90,07	94,26
Tessuto ignifugo	89,99	96,97	101,16
Solo microfibra ignifuga	96,99	103,97	108,16
Finta pelle ignifuga	89,99	96,97	101,16
Faggio [Ø40 sp. 16 mm]	92,23	99,21	103,40
SOVRAPPREZZO			
Anello plastica grigio metallizzato	1,28		

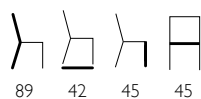

89 42 45 45

# ELENA LUX

Telaio in tubo di acciaio Ø22 mm.  
Piedini neri. Sovrapponibile.

modello sedia	modello seduta	colore seduta	colore telaio
938/LUX	454	blu	9



modello sedia	modello seduta	colore seduta	colore telaio
938/LUX	476	P128	9

modello sedia	modello seduta	colore seduta	colore telaio
938/LUX	454	arancio	6



modello sedia	modello seduta	colore seduta	colore telaio
938/LUX	454	verde	9

## ELENA LUX - SEDIA

Sedile	Verniciatura		
	serie	fuori serie	cromo
Finta paglia a scatto o fiore	69,88	76,87	81,06
Tex Plast Ø 40 a scatto	78,14	85,14	89,33
Vera paglia	90,84	97,82	102,01
Finta pelle	87,29	94,27	98,46
Tessuto normale	87,29	94,27	98,46
Solo tessuto o Skay ignifugo	90,74	97,72	101,91
Solo microfibra ignifuga	97,74	104,72	108,91
Faggio [Ø40 sp. 16 mm]	96,43	103,41	107,6
SOVRAPPREZZO			
Anello plastica grigio metallizzato	1,28		

# ERIKA

Telaio in tubo di acciaio 25X25 mm.  
Piedini neri.

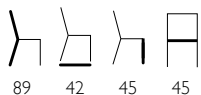

89 42 45 45



modello sedia	modello seduta	colore seduta	colore telaio
951	454	rosso	24



modello sedia	modello seduta	colore seduta	colore telaio
951	476	P01	6



modello sedia	modello seduta	colore seduta	colore telaio
951	476	P128	6



modello sedia	modello seduta	colore seduta	colore telaio
951	476	P97	9

## ERIKA - SEDIA

Sedile	Verniciatura		
	serie	fuori serie	cromo
Finta paglia a scatto o fiore	79,28	86,26	90,45
Tex Plast Ø 40 a scatto	87,55	94,53	98,72
Vera paglia	100,24	107,22	111,41
Skay normale	96,69	103,67	107,86
Tessuto normale	96,69	103,67	107,86
Solo tessuto o Skay ignifugo	100,14	107,12	111,31
Solo microfibra ignifuga	107,14	114,12	118,31
Faggio multistrato [sp. 16 mm Ø40]	105,83	112,81	117,00
SOVRAPPREZZO			
Anello plastica grigio metallizzato	1,28		



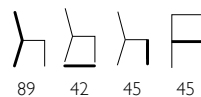

# GIULIA

Telaio in tubo di acciaio 25X25 mm.  
Piedini neri.

modello sedia	modello seduta	colore seduta	colore telaio
961	476	P01	23 SAT



modello sedia	modello seduta	colore seduta	colore telaio
961	452/S.AN.	grigio metallizzato	6

modello sedia	modello seduta	colore seduta	colore telaio
961	476	P128	6



modello sedia	modello seduta	colore seduta	colore telaio
961	476	P97	6

## GIULIA - SEDIA

Sedile	Verniciatura		
	serie	fuori serie	romo
Finta paglia a scatto o fiore	76,23	83,22	87,44
Tex Plast Ø 40 a scatto	84,50	91,49	95,70
Vera paglia	97,19	104,17	108,36
Skay normale	93,64	100,62	104,81
Tessuto normale	93,64	100,62	104,81
Solo tessuto o Skay ignifugo	97,09	104,07	108,26
Solo microfibra ignifuga	104,09	111,07	115,26
Faggio multistrato [sp. 16 mm Ø40]	102,78	109,76	113,95
SOVRAPPREZZO			
Anello plastica grigio metallizzato	1,28		

# ELENA - SGABELLO

Telaio in tubo di acciaio Ø 25 mm.

Piedini neri.

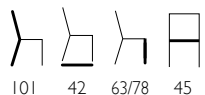

101 42 63/78 45

modello sgabello	modello seduta	colore seduta	colore telaio
968	476	P87	9



## ELENA - SGABELLO H. 62-78

Sedile	Verniciatura		
	serie	fuori serie	cromo
Finta paglia a scatto nero forato	78,27	85,25	89,44
Tex Plast a scatto	86,54	93,52	97,71
Faggio multistrato [Ø40 sp. 16 mm]	104,82	111,8	115,99
Finta pelle	95,68	102,66	106,85
<b>SOVRAPPREZZO</b>			
Anello plastica grigio metallizzato	1,28		

# ELENA LUX - SGABELLO

Telaio in tubo di acciaio Ø 25 mm.

Piedini neri.

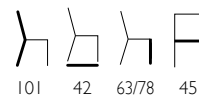

101 42 63/78 45

modello sgabello	modello seduta	colore seduta	colore telaio
968/LUX	476	P128	6



## ELENA LUX - SGABELLO H. 62-78

Sedile	Verniciatura		
	serie	fuori serie	cromo
Finta paglia a scatto nero forato	82,46	89,44	93,63
Tex Plast a scatto	90,73	97,71	101,90
Faggio multistrato [Ø40 sp. 16 mm]	109,01	115,99	120,18
Finta pelle	99,87	106,85	111,04
<b>SOVRAPPREZZO</b>			
Anello plastica grigio metallizzato	1,28		

# GRAN BAR - SGABELLO

Telaio in tubo di acciaio Ø 22 mm.  
Piedini neri. Sovrapponibile

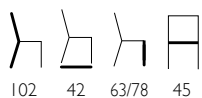

102 42 63/78 45

modello sgabello	modello seduta	colore seduta	colore telaio
915	462	(30) nero 991	cromato



modello sgabello	modello seduta	colore seduta	colore telaio
915	462	(31) bordeaux 502	1

## GRAN BAR - SGABELLO

Sedile	Verniciatura		
	serie	fuori serie	cromo
Finta paglia a scatto	74,07	81,06	85,25
Tex Plast Ø 40 a scatto	82,34	89,33	93,52
Finta pelle	91,48	98,46	102,65
Tessuto	91,48	98,46	102,65
Tessuto ignifugo Classe M1	98,38	105,36	109,55
Solo tessuto ignifugo	94,93	101,91	106,10
Solo microfibra ignifuga	101,93	108,91	113,10
Solo Skay ignifugo	94,93	101,91	106,10
Faggio [Ø40 sp. 16 mm]	100,62	107,6	111,79
<b>SOVRAPPREZZO</b>			
Cromatura	49,50		
Anello plastica grigio metallizzato	1,28		
Variante schienale riccioli forgiati		15,38	

# JESSICA - SGABELLO

Telaio in tubo di acciaio Ø 25 mm.  
Piedini neri. Sovrapponibile

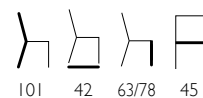

101 42 63/78 45

modello sgabello	modello seduta	colore seduta e schienale	colore telaio
926	476	P87	9



modello sgabello	modello seduta	colore seduta	colore telaio
925	452/S.AN.	nero	6

## JESSICA - SGABELLO H. 78

Sedile	Verniciatura		
	serie	fuori serie	cromo
Finta paglia a scatto	78,27	85,25	89,44
Tex Plast Ø 40 a scatto	86,54	93,52	97,71
Finta pelle	95,68	102,66	106,85
Tessuto	95,68	102,66	106,85
Finta paglia ignifugo	83,25	90,23	94,42
Tessuto ignifugo	102,58	109,56	113,75
Solo tessuto ignifugo	99,13	106,11	110,30
Solo microfibra ignifuga	106,13	113,11	117,30
Solo Skay ignifugo	99,13	106,11	110,30
Faggio [Ø40 sp. 16 mm]	104,82	111,80	116,00
Faggio [Ø40 sp. 16 mm] (+SCHIENALE FAGGIO Ø35)	129,98	136,96	141,15
<b>SOVRAPPREZZO</b>			
Anello plastica grigio metallizzato	1,28		
Variante tondini schienale		15,38	

# BISTROT - SGABELLO H 65-78

Telaio in tubo di acciaio Ø22 mm.  
Piedini neri. Sovrapponibile



modello sgabello	modello seduta	colore seduta	colore telaio
912/H78	476	P128	9



modello sgabello	modello seduta	colore seduta	colore telaio
912/H78	452	paglia-nero	1

## BISTROT SGABELLO H. 65-78

Sedile	Verniciatura		
	serie	fuori serie	chromo
Finta paglia a scatto o fiore	62,89	69,88	74,07
Tex Plast Ø 40 a scatto	71,16	78,14	82,34
Finta pelle	80,3	87,28	91,47
Tessuto	80,3	87,28	91,47
Tessuto ignifugo Classe M1	87,2	94,18	98,37
Solo tessuto ignifugo	83,75	90,73	94,92
Solo microfibra ignifuga	90,75	97,73	101,92
Solo Skay ignifugo	83,75	90,73	94,92
Faggio [Ø40 sp. 16 mm]	89,44	96,42	100,61
SOVRAPPREZZO			
Anello plastica grigio metallizzato	1,28		

# BISTROT - SGABELLO H 45

Telaio in tubo di acciaio Ø22 mm.  
Piedini neri. Sovrapponibile



modello sgabello	modello seduta	colore seduta	colore telaio
912/H45	462	904 blu	1



modello sgabello	modello seduta	colore seduta	colore telaio
912/H45	452	paglia	1

## BISTROT SGABELLO H. 45

Sedile	Verniciatura		
	serie	fuori serie	chromo
Finta paglia a scatto o fiore	44,73	51,71	55,90
Tex Plast Ø 40 a scatto	53,00	59,98	64,17
Finta pelle	62,14	69,12	73,31
Tessuto	62,14	69,12	73,31
Tessuto ignifugo Classe M1	69,04	76,02	80,21
Solo tessuto ignifugo	65,59	72,57	76,76
Solo microfibra ignifuga	72,59	79,57	83,76
Solo Skay ignifugo	65,59	72,57	76,76
Faggio [Ø40 sp. 16 mm]	71,28	78,26	82,45
SOVRAPPREZZO			
Anello plastica grigio metallizzato	1,28		

# LIBERTY - SGABELLO

Telaio in tubo di acciaio Ø 30 mm.  
Piedini neri.



78



37



modello sgabello	modello seduta	colore seduta	colore telaio
924	461/Ø35	(39) rosso 501	1

## LIBERTY SGABELLO

Sedile	Verniciatura		
	serie	fuori serie	cromo
Finta pelle	102,03	109,01	113,20
Tessuto	103,42	110,41	114,60
Tessuto ignifugo Classe M1	107,61	114,60	118,79
SOVRAPPREZZO			
Cromatura	49,50		

# ALFEO - SGABELLO

Telaio in tubo di acciaio stelo 80 mm.  
Piedini neri.



78



45



modello sgabello	modello seduta	colore seduta	colore telaio
919	462/Ø32	giallo 9315	1

## ALFEO SGABELLO H. 78

Sedile	Verniciatura		
	serie	fuori serie	cromo
Finta pelle [Ø32 sp. 10]	177,87	184,86	189,05
Tessuto o Skay ignifugo	190,58	197,56	201,75

# IRIS - SGABELLO

Telaio in tubo di acciaio Ø 25 mm.  
Piedini neri. Sovrapponibile.



modello sgabello	modello seduta	colore seduta	colore telaio
927	461/35	bordeaux 502	6

## IRIS - SGABELLO

Sedile	Verniciatura		
	serie	fuori serie	cromo
Finta pelle [Ø32 cm sp. 10 mm]	117,39	124,38	128,58
Tessuto [Ø32 cm sp. 10 mm]	120,19	127,18	131,37
Solo tessuto ignifugo [Ø32 cm sp. 10 mm]	125,79	132,77	136,96
Solo Skay ignifugo [Ø32 cm sp. 10 mm]	129,98	136,96	141,15
SOVRAPPREZZO			
Cromatura	49,50		

# JOLLY - SGABELLO

Telaio in tubo di acciaio.  
Piedini neri.



modello sgabello	modello seduta	colore seduta	colore telaio
937	461/Ø35	904 blu	1

## JOLLY - SGABELLO H. 45

Sedile	Verniciatura		
	serie	fuori serie	cromo
Finta pelle Ø35 senza anello	60,09	67,07	71,26
Tessuto	61,49	68,47	72,66
Tessuto ignifugo	73,18	80,16	84,35

# CUBO - SGABELLO

Telaio in tubo di acciaio 25x25 mm.  
Piedini neri.



modello sgabello	modello seduta
917	CUBO
colore seduta	colore telaio
(30) nero 991	26

## CUBO - SGABELLO H.78

Sedile	Verniciatura		
	serie	fuori serie	cromo
Finta pelle [36x36 cm sp. 1.8mm]	130,00	136,98	141,17
Solo Skay ignifugo [36x36 cm sp. 1.8mm]	140,00	146,98	151,17
Tessuto [36x36 cm sp. 1.8mm]	130,00	136,98	141,17
Tessuto ignifugo [36x36 cm sp. 1.8mm]	140,00	146,98	151,17

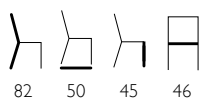

# JESSICA I - SEDIA

Telaio in tubo di acciaio Ø25 mm.  
Piedini neri. Sovrapponibile.

modello sedia	modello seduta	colore seduta	colore telaio
940-1	476	P87	22

modello sedia	modello seduta	colore seduta	colore telaio
940-1	452/S.AN.	grigio metallizzato	24



modello sedia	modello seduta	colore seduta	colore telaio
940-1	462	801 verde	1



modello sedia	modello seduta	colore seduta	colore telaio
940-1	476	P87	9

## JESSICA I - SEDIA

Sedile	Verniciatura		
	serie	fuori serie	cromo
Finta paglia a scatto o fiore	54,51	61,49	65,68
Tex Plast Ø 40 a scatto	62,78	69,76	73,95
Vera paglia	75,47	82,45	86,64
Finta pelle	71,91	78,89	83,08
Tessuto	71,91	78,89	83,08
Tessuto ignifugo	78,82	85,80	89,99
Solo microfibra ignifuga	85,82	92,80	96,99
Finta paglia a scatto ignifugo Classe M1	60,10	67,08	71,27
Faggio multistrato [sp. 16 mm Ø40]	81,06	88,04	92,23
Faggio [sp. 16 mm Ø40] + SCHIENALE FAGGIO Ø35	107,62	114,60	118,79
SOVRAPPREZZO			
Anello plastica grigio metallizzato	1,29		

# JESSICA 2 - SEDIA

Telaio in tubo di acciaio Ø25 mm.  
Piedini neri. Sovrapponibile.

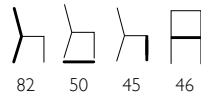

modello sedia	modello seduta	colore seduta	colore telaio
940-2	452	paglia-nero	I



modello sedia	modello seduta	colore seduta	colore telaio
940-2	476	P21	23 LUC



modello sedia	modello seduta	colore seduta	colore telaio
940-2	452/S.AN.	greigio metallizzato	6

## JESSICA 2 - SEDIA

Sedile	Verniciatura		
	serie	fuori serie	chromo
Finta paglia a scatto o fiore	54,51	61,49	65,68
Tex Plast Ø 40 a scatto	62,78	69,76	73,95
Vera paglia	75,47	82,45	86,64
Finta pelle	71,91	78,89	83,08
Tessuto	71,91	78,89	83,08
Tessuto ignifugo	78,82	85,80	89,99
Solo microfibra ignifuga	85,82	92,80	96,99
Finta paglia a scatto ignifugo Classe M1	60,10	67,08	71,27
Faggio multistrato [sp. 16 mm Ø40]	81,06	88,04	92,23
Faggio [sp. 16 mm Ø40 ] + SCHIENALE FAGGIO Ø35	107,62	114,60	118,79
<b>SOVRAPPREZZO</b>			
Anello plastica grigio metallizzato	1,29		



modello sedia	modello seduta	colore seduta	colore telaio
940-2	443	paglia	I



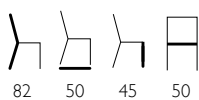

# JESSICA - POLTRONA

Telaio in tubo di acciaio Ø25 mm.  
Piedini neri. Sovrapponibile.

modello sedia	modello seduta	colore seduta	colore telaio
945	476	P01	1



modello sedia	modello seduta	colore seduta	colore telaio
945	452/S.AN.	nero	6



modello sedia	modello seduta	colore seduta	colore telaio
945	476	P97	1



modello sedia	modello seduta	colore seduta	colore telaio
945	454	arancio	23 SAT

## JESSICA - POLTRONA

Sedile	Verniciatura		
	serie	fuori serie	cromo
Finta paglia a scatto	57,31	64,29	68,48
Tex Plast Ø 40 a scatto	65,58	72,56	76,75
Vera paglia	78,27	85,25	89,44
Imbottito finta pelle	74,72	81,7	85,89
Tessuto A	74,72	81,7	85,89
Tessuto ignifugo	81,62	88,6	92,79
Solo microfibra ignifuga	88,62	95,60	99,79
Finta paglia a scatto ignifugo	62,9	69,88	74,07
Faggio multistrato [Ø40 sp. 16 mm]	83,86	90,84	95,03
Faggio multistrato [Ø40 sp. 16 mm] + schienale faggio Ø35	113,21	120,19	124,38
SOVRAPPREZZO			
Anello plastica grigio metallizzato	1,29		

# SABINA 2005

Telaio in tubo di acciaio Ø 22 mm.  
Piedini neri. Sovrapponibile.

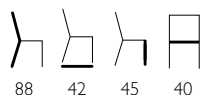

88 42 45 40



modello sedia	modello seduta	colore seduta	colore telaio
920	452/S.AN.	nero	6



modello sedia	modello seduta	colore seduta	colore telaio
920	476	P128	23 SAT



modello sedia	modello seduta	colore seduta	colore telaio
920	476	P87	9



modello sedia	modello seduta	colore seduta	colore telaio
920	462	panna 11549	23 LUC

## SABINA 2005 - SEDIA

Sedile	Verniciatura		
	serie	fuori serie	chromo
Finta paglia a scatto	52,10	59,08	63,27
Tex Plast Ø 40 a scatto	60,37	67,35	71,54
Finta pelle	69,51	76,49	80,68
Tessuto	69,51	76,49	80,68
Solo tessuto o Skay ignifugo	72,96	79,94	84,13
Solo microfibra ignifuga	79,96	86,94	91,13
Faggio multistrato [sp. 16 mm Ø40]	78,65	85,63	89,82
SOVRAPPREZZO			
Anello plastica grigio metallizzato	1,19		

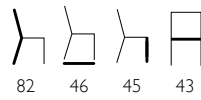

# PIZZA RAPIDA

Telaio in tubo di acciaio Ø25 mm.  
Piedini neri. Sovrapponibile.



modello sedia	modello seduta	colore seduta	colore telaio
914	484A	Verde Chiaro	6



modello sedia	modello seduta	colore seduta	colore telaio
914	484A	blu scuro	23 SAT



modello sedia	modello seduta	colore seduta	colore telaio
914	484A	bordeaux	9



modello sedia	modello seduta	colore seduta	colore telaio
914	484A	rosso	6

## PIZZA RAPIDA - SEDIA

Sedile	Verniciatura		
	serie	fuori serie	chromo
Finta pelle	81,06	88,04	92,24
Tessuto A	83,85	90,84	95,03
Tessuto ignifugo	92,24	99,23	103,42
Solo microfibra ignifuga	99,24	106,23	110,42
Finta pelle ignifuga	106,22	113,20	117,39

# DIANA I - POLTRONA

Telaio in tubo di acciaio Ø 25 mm.  
Piedini neri. Sovrapponibile.

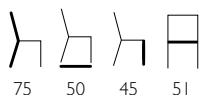

modello poltrona	modello seduta	colore seduta	colore telaio
322	447	nero	I



modello poltrona	modello seduta	colore seduta	colore telaio
322	447	verde.	6



modello poltrona	modello seduta	colore seduta	colore telaio
322	447	paglia-nero	22

## DIANA I - POLTRONA

Sedile	Verniciatura		
	serie	fuori serie	cromo
Polipropilene rigato (4,34 Kg)	48,92	55,90	60,09
Finta paglia con anello (4,42 Kg)	48,91	55,89	60,08
Finta paglia con anello ignifugo	51,45	58,43	62,62
Finta pelle	64,04	71,02	75,21
Finta pelle ignifugo	71,17	78,15	82,34
Tessuto	64,04	71,02	75,21
Tessuto ignifugo Classe M1	71,17	78,15	82,34
Solo tessuto ignifugo	67,59	74,57	78,76
Solo microfibra ignifuga	74,59	81,57	85,76
Solo Skay ignifugo	67,59	74,57	78,76
SOVRAPPREZZO			
Anello plastica grigio metallizzato	1,29		



modello poltrona	modello seduta	colore seduta	colore telaio
322	447	blu	24

# CINZIA FERRO/CINZIA FERRO3 - POLTRONA

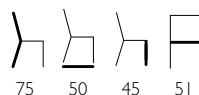

Telaio in tubo di acciaio Ø 25 mm.  
Piedini neri. Sovrapponibile.



modello poltrona	modello seduta	colore seduta	colore telaio
326	447	nero	24



modello poltrona	modello seduta	colore seduta	colore telaio
326	454	nero	6



modello poltrona	modello seduta	colore seduta	colore telaio
326	454	blu - grigio metallizzato	9



modello poltrona	modello seduta	colore seduta	colore telaio
326	454	verde - grigio metallizzato	9

## CINZIA FERRO - seduta rotonda

Sedile rotondo	Verniciatura		
	serie	fuori serie	cromo
Finta paglia a scatto con anello / Forata a scatto senza anello	48,92	55,9	60,09
Tex-plast	57,19	64,17	68,36
Vera paglia	69,88	76,86	81,05
Fiore a scatto con anello	48,92	55,9	60,09
Finta paglia ignifugo con anello	54,51	61,49	65,68
Tessuto con anello	66,33	73,31	77,5
Tessuto ignifugo con anello	73,23	80,21	84,4
Finta pelle con anello	66,33	73,31	77,5
Finta pelle ignifuga con anello	73,23	80,21	84,4
Faggio multistrato	75,47	82,45	86,64
Solo tessuto ignifugo con anello	69,78	76,76	80,95
Solo microfibra ignifuga con anello	76,78	83,76	87,95
Solo pelle ignifuga con anello	69,78	76,76	80,95
SOVRAPPREZZO			
Anello plastica grigio metallizzato	1,29		

## CINZIA FERRO 3 - seduta sagomata a trapezio

Sedile sagomato a trapezio	Verniciatura		
	serie	fuori serie	cromo
Finta paglia a scatto con anello / Forata a scatto senza anello	48,92	55,9	60,09
Finta paglia ignifugo con anello	51,46	58,44	62,63
Tessuto con anello	64,04	71,02	75,21
Tessuto ignifugo con anello	71,17	78,15	82,34
Finta pelle con anello	64,04	71,02	75,21
Finta pelle ignifuga con anello	71,17	78,15	82,34
Solo tessuto ignifugo con anello	67,60	74,58	78,77
Solo microfibra ignifuga con anello	74,60	81,58	85,77
Solo pelle ignifuga con anello	67,60	74,58	78,77
SOVRAPPREZZO			
Anello plastica grigio metallizzato	1,29		

# ADRIA COMFORT - POLTRONA

Telaio in tubo di acciaio Ø 25 mm.

Piedini neri. Sovrapponibile.

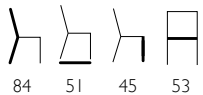

84 51 45 53



modello poltrona	modello seduta	colore seduta	colore telaio
936	484	bordeaux	6



modello poltrona	modello seduta	colore seduta	colore telaio
936	484	blu	6



modello poltrona	modello seduta	colore seduta	colore telaio
936	484	verde	6



modello poltrona	modello seduta	colore seduta	colore telaio
936	484	nero 991	1

## ADRIA COMFORT - POLTRONA

Sedile	Verniciatura		
	serie	fuori serie	cromo
Finta pelle	122,98	129,98	134,17
Tessuto	125,79	132,77	136,96
Tessuto ignifugo Classe M1	143,95	150,93	155,13
Solo tessuto ignifugo	139,76	145,59	150,93
Solo microfibra ignifuga	146,76	152,59	157,93
Solo Skay ignifugo	141,15	148,14	152,33

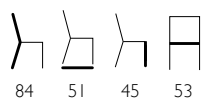

# ADRIA - POLTRONA

Telaio in tubo di acciaio Ø 25 mm.  
Piedini neri. Sovrapponibile.



modello poltrona	modello seduta	colore seduta	colore telaio
918	484 ign.	9715 arancio	6



modello poltrona	modello seduta	colore seduta	colore telaio
918	484	bordeaux	6



modello poltrona	modello seduta	colore seduta	colore telaio
918	484 ign.	verde	6



modello poltrona	modello seduta	colore seduta	colore telaio
918	484 ign.	rosso	1

## ADRIA - POLTRONA

Sedile	Verniciatura		
	serie	fuori serie	cromo
Finta pelle	99,23	106,22	110,41
Tessuto	99,23	106,22	110,41
Tessuto ignifugo Classe M1	106,36	113,34	117,53
Solo tessuto ignifugo	102,79	109,77	113,96
Solo microfibra ignifuga	109,79	116,77	120,96
Solo Skay ignifugo	102,79	109,77	113,96

# SELENIA - POLTRONA

Telaio in tubo di acciaio Ø30 mm.

Sovrapponibile.

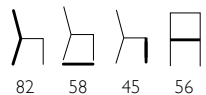

82 58 45 56



modello poltrona	modello seduta	colore seduta	colore telaio
939	497 ignifuga	blu scuro	9



modello poltrona	modello seduta	colore seduta	colore telaio
939	497	blu	6



modello poltrona	modello seduta	colore seduta	colore telaio
939	497 ignifuga	bordeaux	22



modello poltrona	modello seduta	colore seduta	colore telaio
939	497 ignifuga	verde scuro	9

## SELENIA - POLTRONA

Sedile	Verniciatura		
	serie	fuori serie	cromo
Imbottito finta pelle	162,12	169,10	173,29
Tessuto A	163,52	170,50	174,69
Tessuto ignifugo e finta pelle ignifuga	180,28	187,28	191,47
Solo microfibra ignifuga	195,28	202,28	206,47



# CICALA

Telaio in tubo di lega alluminio Ø 25 mm.  
Piedini neri, Sovrapponibile.

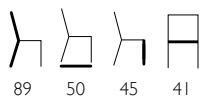

modello sedia	modello seduta	colore seduta	colore telaio
944	447	paglia-nero	1

# CICALA COMFORT

Telaio in tubo di lega alluminio Ø 25 mm.  
Piedini neri, Sovrapponibile.

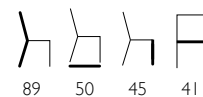

modello sedia	modello seduta	colore seduta	colore telaio
944 CONF	447 imbottito	bordeaux 205 - grigio met.	6

## CICALA - SEDIA

Sedile	Verniciatura		
	serie	fuori serie	chromo
Polipropilene rigato o forato	67,08	74,07	78,27
Finta paglia con anello	67,08	74,07	78,27
Imbottito finta pelle	82,20	89,18	93,37
Tessuto A	82,20	89,18	93,37
Tessuto ignifugo	89,33	96,31	100,5
Solo microfibra ignifuga	96,33	103,31	107,50
<b>SOVRAPPREZZO</b>			
Anello plastica grigio metallizzato	1,29		

## CICALA COMFORT - SEDIA

Sedile	Verniciatura		
	serie	fuori serie	chromo
Imbottito finta pelle	116,00	122,98	127,18
Tessuto A	117,39	124,38	128,58
Tessuto ignifugo	135,56	142,55	146,74
Solo microfibra ignifuga	150,56	157,55	161,74
<b>SOVRAPPREZZO</b>			
Anello plastica grigio metallizzato	1,29		
Anello in metallo imb. inserito all'interno		12,57	

# IMPERO

Telaio in tubo di acciaio Ø25 mm.  
Piedini neri. Sovrapponibile.

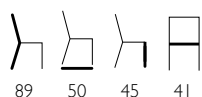

modello sedia	modello seduta	colore seduta	colore telaio
600	447 imbottito	blu chiaro anello metallo	1



modello sedia	modello seduta	colore seduta	colore telaio
600	447 imbottito	bordeaux anello plastica nero	1



modello sedia	modello seduta	colore seduta	colore telaio
600	447 imbottito	nero anello psastica - grigio met.	6



modello sedia	modello seduta	colore seduta	colore telaio
600	447 imbottito	verde scuro anello psastica grigio met	23 SAT

## IMPERO - SEDIA

Sedile	Verniciatura		
	serie	fuori serie	chromo
Polipropilene rigato	64,28	71,28	75,47
Finta paglia con anello	64,28	71,28	75,47
Imbottito finta pelle	79,41	86,39	90,58
Tessuto A	79,41	86,39	90,58
Tessuto ignifugo	86,53	93,51	97,70
Solo microfibra ignifuga	93,53	100,51	104,70
Finta pelle Skay ignifuga	79,41	86,39	90,58
SOVRAPPREZZO			
Anello plastica grigio metallizzato	1,29		
Anello in metallo imb.inserito all'interno		12,47	

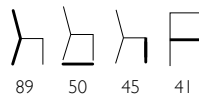

# IMPERO SPECIAL

Telaio in tubo di acciaio Ø 25 mm.  
Piedini neri.

modello sedia	modello seduta	colore seduta	colore telaio
601	502A imbottito	verde scuro	anello metallo



modello sedia	modello seduta	colore seduta	colore telaio
601	502A imbottito	nero	anello metallo

modello sedia	modello seduta	colore seduta	colore telaio
601	502A imbottito	bordeaux	anello metallo



modello sedia	modello seduta	colore seduta	colore telaio
601	502A imbottito	blu	anello metallo



## IMPERO SPECIAL - SEDIA

Sedile	Verniciatura		
	serie	fuori serie	chromo
Imbottito finta pelle	116,00	122,98	127,18
Tessuto A	117,39	124,38	128,58
Tessuto ignifugo	136,96	143,95	148,14
Solo microfibra ignifuga	151,96	158,95	163,14
Finta pelle Skay ignifuga	136,96	143,95	148,14
SOVRAPPREZZO			
Anello plastica grigio metallizzato	1,29		
Anello in metallo imb. inserito all'interno		12,47	

# MILANO

Telaio in tubo di acciaio Ø 25mm.  
Piedini Neri. Sovrapponibile.

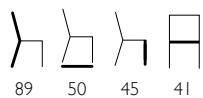

modello sedia	modello seduta	colore seduta	colore telaio
942	446	nero	I

## MILANO - SEDIA

Sedile	Verniciatura		
	serie	fuori serie	cromo
Polipropilene rigato o forato	61,49	68,48	72,68
Finta paglia con anello	61,49	68,48	72,68
Imbottito finta pelle	76,62	83,60	87,79
Tessuto A	76,62	83,60	87,79
Tessuto ignifugo	83,74	90,72	94,91
Solo microfibra ignifuga	90,74	97,72	101,91
Finta pelle Skay ignifuga	83,74	90,72	94,91
SOVRAPPREZZO			
Anello plastica grigio metallizzato	1,29		

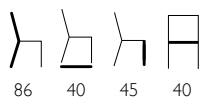

modello	colore
203	Verde scuro 078

## BISTROT RESINA - SEDIA

Sedia in resina impilabile per esterni ed interni.

Colori disponibili per BISTROT RESINA

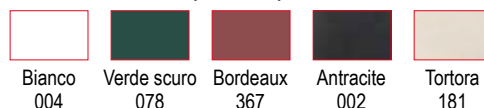

### BISTROT RESINA SEDIA

Descrizione	Prezzo
	serie
Colore BIANCO, confezione 76 PZ.	26,00
Colore BIANCO, confezione 14 PZ.	28,60
Colore VERDE SCURO, confezione 76 PZ.	27,00
Colore VERDE SCURO, confezione 14 PZ.	30,00
Colori BORDEAUX, ANTRACITE, TORTORA, solo confezione 14 PZ.	37,00



modello	colore
201	bianco

## FODERA BIANCA + GOMMA PER SEDIA BISTROT RESINA

### FODERA BIANCA + GOMMA PER SEDIA BISTROT RESINA

Descrizione	Prezzo
	serie
Fodera bianca + gomma su sedile per sedia Bistrot Resina	49,50

## FODERA JAQUARD TESSUTO TRAPUNTATO

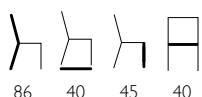

### FODERA JAQUARD TESSUTO TRAPUNTATO

Descrizione	Prezzo
	serie
Fodera jaquard tessuto trapuntato	80,00

modello	colore
200	panna

# SEDIA PIEGHEVOLE IN LEGNO

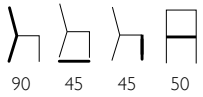

90 45 45 50

## SEDIA PIEGEVOLE

Descrizione	Prezzo serie
Sedia Piegevole	34,65



modello sedia	colore sedia
100	P01

# SEDIA REGISTA IN LEGNO

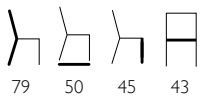

79 50 45 43

## SEDIA REGISTA

Descrizione	Prezzo serie
Sedia regista	98,18



modello sedia	colore seduta	colore telaio
101	ecru	P87

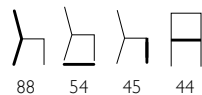

# CAROLINA

Telaio in tubo di acciaio Ø22 mm.  
Piedini neri. Sovrapponibile.

modello sedia	modello seduta	colore seduta	colore telaio
923	454	blu anello nero	19



modello sedia	modello seduta	colore seduta	colore telaio
923	454	verde anello grigio met.	6



modello sedia	modello seduta	colore seduta	colore telaio
923	452	paglia anello - nero	1



modello sedia	modello seduta	colore seduta	colore telaio
923	454	arancio anello grigio met.	6

## CAROLINA - SEDIA

Sedile	Verniciatura		
	serie	fuori serie	chromo
Finta paglia a scatto o fiore	51,71	58,70	62,89
Tex Plast Ø 40 a scatto	59,97	66,95	71,14
Imbottito finta pelle	69,11	76,09	80,28
Tessuto	69,11	76,09	80,28
Tessuto ignifugo	76,01	82,99	87,18
Solo microfibra ignifuga	83,01	89,99	94,18
Finta pelle Skay ignifuga	76,01	82,99	87,18
Finta paglia a scatto Classe M1	57,29	64,27	68,46
SOVRAPPREZZO			
Anello plastica grigio metallizzato	1,29		

# NIDO - SEDIA

Monoblocco polipropilene.  
Colori: ROSSO, VERDE, GIALLO, BLU.

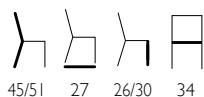

modello sedia	colore
150	rosso



modello sedia	colore
150	giallo



modello sedia	colore
150	verde



modello sedia	colore
150	blu

## NIDO - SEDIA

Sedile e schienale	Verniciatura
	serie
Monoblocco poliprop. col. ROSSO-VERDE-GIALLO-BLU Con kit piedini per h. 26 e h. 30	<b>38,12</b>

# BANCO MONOPOSTO

Struttura in tubo di acciaio Ø28 mm.

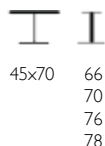

modello base	modello piano	colore piano	colore gambe
500	084	avorio	I

## BANCO MONOPOSTO - SCUOLA

Piano	Verniciatura		
	serie	fuori serie	cromo
Piano nobilitato col.AVORIO bordo ABS FG.NAT. [45X70] Sottopiano in LAM. STRATIFICATO sp. 12mm.	<b>107,05</b>	<b>114,04</b>	<b>118,23</b>
Piano nobilitato col.AVORIO bordo ABS FG.NAT. [45X70] Sottopiano in LAM. STRATIFICATO sp. 12mm.	<b>127,05</b>	<b>134,04</b>	<b>138,23</b>
Piano nobilitato col.AVORIO bordo ABS FG.NAT. [45X110]	<b>135,00</b>	<b>141,99</b>	<b>146,18</b>
Piano nobilitato col.AVORIO bordo ABS FG.NAT. [45X110] Sottopiano in LAM. STRATIFICATO sp. 12mm.	<b>165,00</b>	<b>171,99</b>	<b>176,18</b>

# LAURETTA ASILO

Telaio in tubo di acciaio Ø20 mm.  
Piedini neri. Sovrapponibile.

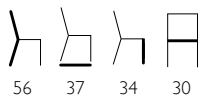

modello sedia	modello seduta	colore seduta	colore telaio
623/ASILO	471	P01	I

34 cm



## LAURETTA ASILO - SEDIA

Sedile e schienale	Verniciatura		
	serie	fuori serie	cromo
Laminato color FAGGIO NATURALE H.34	<b>44,73</b>	<b>51,71</b>	<b>55,90</b>
<b>SOVRAPPREZZO</b>			
Laminato nei colori fuori serie	<b>4,19</b>		



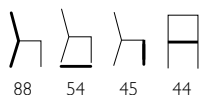

45 cm

modello sedia	modello seduta	colore seduta	colore telaio
623	482	43 nuovo Teak Opaco	I



modello sedia	modello seduta	colore seduta	colore telaio
623	482	42 Noce Tanzania	I

# LAURETTA

Telaio in tubo di acciaio Ø20 mm.  
Piedini neri. Sovrapponibile.



modello sedia	modello seduta	colore seduta	colore telaio
623	482	43 nuovo Teak Opaco	I



modello sedia	modello seduta	colore seduta	colore telaio
623	472	cuoio	I



modello sedia	modello seduta	colore seduta	colore telaio
623	482	P01	6

## LAURETTA - SEDIA

Sedile e schienale	Verniciatura		
	serie	fuori serie	cromo
Laminato nei colori di serie (NUOVO TEAK OPACO e NOCE TANZANIA)	44,73	51,71	55,90
Finta pelle normale	50,31	57,30	61,49
SOVRAPPREZZO			
Laminato nei colori fuori serie (FAGGIO NATURALE E NERO)	4,19		

## LAURETTA NEW DESIGN

Telaio in tubo di acciaio Ø20 mm.  
Piedini neri. Sovrapponibile.

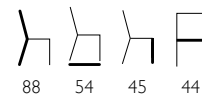

modello sedia	modello seduta	colore seduta	colore telaio
850	482/RET	nero	10

modello sedia	modello seduta	colore seduta	colore telaio
850	482/RET	nero	2

## LAURETTA NEW DESIGN - SEDIA

Sedile e schienale	Verniciatura		
	serie	fuori serie	cromo
Laminato nei colori di serie (NUOVO TEAK OPACO e NOCE TANZANIA)	80,00	86,99	91,20
SOVRAPPREZZO			
Laminato nei colori fuori serie (FAGGIO NATURALE E NERO)	4,19		

# ATHENA - SEDIA

Gambe in tubo di lega di alluminio Ø25 mm opache grezze.  
Piedini neri. Sovrapponibile box 4 pz.

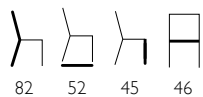

modello sedia	colore seduta	colore telaio
830	verde mela	Alluminio grezzo



modello sedia	colore seduta	colore telaio
830	arancio	Alluminio grezzo

## ATHENA - SEDIA

Sedile e schienale	
SEDIA Polipropilene nei colori (rosso - arancio - azzurro - nero - verde mela - bianco - avorio)	<b>66,99</b>
<b>CONFEZIONE 4 PZ.</b>	

# ATHENA - POLTRONA

Gambe in tubo di lega di alluminio Ø25 mm opache grezze.  
Piedini neri. Sovrapponibile box 4 pz.

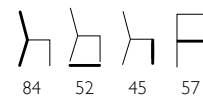

modello poltrona	colore seduta	colore telaio
830/POLTRONA	avorio	Alluminio grezzo



modello poltrona	colore seduta	colore telaio
830/POLTRONA	azzurro	Alluminio grezzo

## ATHENA - POLTRONA

Sedile e schienale	
SEDIA Polipropilene nei colori (rosso - arancio - azzurro - nero - verde mela - bianco - avorio)	76,04
<b>CONFEZIONE 4 PZ.</b>	

# PARIGI

Sedia in polipropilene. Impilabile.

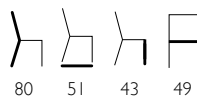

80 51 43 49



modello sedia	colore
890 sedia	antracite



modello sedia	colore
890 sedia	verde mela



modello sedia	colore
890 sedia	arancio



modello sedia	colore
890 sedia	rosso

## Colori disponibili per PARIGI - Sedia

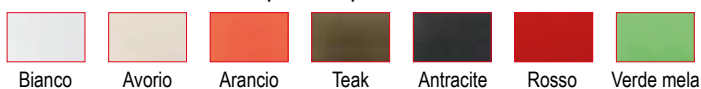

## PARIGI - SEDIA

Sedile e schienale	
SEDIA Polipropilene nei colori (bianco - avorio - arancio - teak - antracite - rosso - verde mela) <b>PREZZO CAD PER QUANTITÀ MINIMA 24 PZ</b>	<b>59,29</b>
SOVRAPPREZZO	
Per ordine minimo 4 pz	<b>7,70 cad</b>

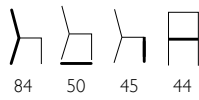

# CRISTINA TUBO

Telaio in tubo di acciaio Ø18 mm, seduta in polipropilene.



modello sedia	modello seduta	colore seduta	colore telaio
700	PULL	verde	cromato



modello sedia	modello seduta	colore seduta	colore telaio
700	PULL	grigio	cromato



modello sedia	modello seduta	colore seduta	colore telaio
700	PULL	arancio	6



modello sedia	modello seduta	colore seduta	colore telaio
700	PULL	rosso	cromato

## Colori disponibili per CRISTINA TUBO - Sedia

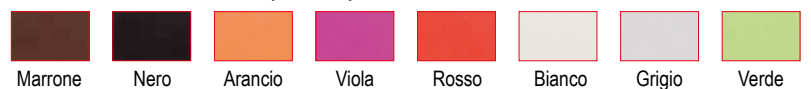

## CRISTINA TUBO - SEDIA

Sedile e schienale	Verniciatura		
	serie	fuori serie	cromo
SEDIA Polipropilene, con struttura verniciata	60,50	67,49	71,68
SEDIA Polipropilene, con struttura cromata	70,18	-	-

# RACE

Struttura tubo tondo Ø 18 mm.  
Piedini neri. Impilabile.

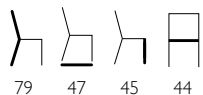

Colori disponibili per RACE - Sedia



modello sedia	modello seduta	colore seduta	colore telaio
800	race	arancio	cromato



## RACE - SEDIA

Sedile e schienale	Verniciatura		
	serie	fuori serie	cromo
Polipropilene, con struttura verniciata	53,00	59,99	64,18
Polipropilene, con struttura cromata	58,00	-	-

# S18-SEDIA AGGANCIABILE

Struttura tubo tondo Ø 18 mm. Piedini neri. Impilabile. Agganciabile.

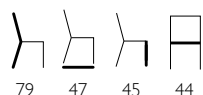

modello sedia	modello seduta	colore seduta	colore telaio
975	S18	Bianco	cromato



modello sedia	modello seduta	colore seduta	colore telaio
975	S18	Arancio	cromato

modello sedia	modello seduta	colore seduta	colore telaio
975	S18	Rosso	cromato

Colori disponibili per S18 - sedia



Scocca	Verniciatura		
	serie	fuori serie	cromo
Polipropilene normale, con struttura verniciata. AGGANCIABILE	45,00	51,98	56,17
Polipropilene ignifuga, con struttura verniciata. AGGANCIABILE	52,00	58,98	63,17
SOVRAPPREZZO			
Struttura cromata	11,44		



modello sedia	modello seduta	colore seduta	colore telaio
975	S18	Verde Mela	cromato

# STRESA / STRESA 2

Telaio in tubo di acciaio Ø18 mm. Piedini neri. Sovrapponibile.

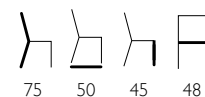

## STRESA

modello sedia	modello seduta	colore seduta	colore telaio
931	422	blu aviazione	I



modello sedia	modello seduta	colore seduta	colore telaio
931	422	rosso	I



STRESA 2  
Sedia agganciabile

modello sedia	modello seduta	colore seduta	colore telaio
931 AGG	422	nero	6

## STRESA 1 - SEDIA

Scocca	Verniciatura		
	serie	fuori serie	Cromo
Moplen D5	37,73	44,73	48,92
Forata in Moplen D6	39,13	46,12	50,31
Moplen D5 ignifugo Classe M1	47,52	54,51	58,70
Forata in Moplen D6 ignifugo Classe M1	48,92	55,90	60,09

## STRESA 2 - SEDIA AGGANCIABILE

Scocca	Verniciatura		
	serie	fuori serie	Cromo
Moplen D5 a vite	44,73	51,71	55,90
Forata in Moplen D6 a vite	46,12	53,11	57,30
Moplen a vite ignifugo Classe M1	50,31	57,30	61,49
Forata in Moplen ignifugo Classe M1	53,11	60,09	64,28
SOVRAPPREZZO			
Braccio saldato fisso + Tavoleta laminato con rotazione 90°	50,31		



modello sedia	modello seduta	colore seduta	colore telaio
931	422	avorio	I

# TURBO - TURBO 2

Telaio in tubo di acciaio. Gambe tubo ovale 30x15 mm. Piedini neri. Sovrapponibile.

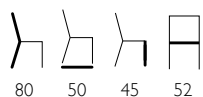

80 50 45 52



modello sedia	modello seduta	colore seduta	colore telaio
913	422	avorio	1

TURBO



modello sedia	modello seduta	colore seduta	colore telaio
913	422	rosso	1



modello sedia	modello seduta	colore seduta	colore telaio
913	422	nero	6



Coppia ganci in plastica per legare le sedie

TURBO 2  
Sedia agganciabile



modello sedia	modello seduta	colore seduta	colore telaio
913 AGG	422	blu aviazione	6

## TURBO - SEDIA

Scocca	Verniciatura		
	serie	fuori serie	chromo
Moplen D5 a vite	44,73	51,71	55,90
Forata in Moplen D6	47,52	54,51	58,70
Moplen D5 ignifugo Classe M1	53,11	60,09	64,28
Forata in Moplen D6 ignifugo Classe M1	57,30	64,28	68,48
Polipropilene a scatto I02	43,36	50,31	54,51
Polipropilene a scatto I02 Classe M1	53,11	60,09	64,28
<b>SOVRAPPREZZO</b>			
Coppia ganci in plastica per legare le sedie	6,60		

## TURBO 2 - SEDIA AGGANCIABILE

Scocca	Verniciatura		
	serie	fuori serie	chromo
Moplen D5 a vite	50,31	57,30	61,49
Forata in Moplen D6	51,71	58,70	62,89
Moplen D5 ignifugo Classe M1	57,30	64,28	68,48
Forata in Moplen D6 ignifugo Classe M1	61,49	68,48	72,68
Polipropilene a scatto I02	47,52	54,51	58,70
Polipropilene a scatto I02 Classe M1	60,09	67,08	71,28



modello sedia	modello seduta	colore seduta	colore telaio
913 AGG-	422	rosso	6



# DORIA / DORIA 2

Telaio in tubo di acciaio. Gambe tubo ovale 30X15 mm.  
Piedini neri. Sovrapponibile.

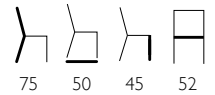

DORIA

modello poltrona	modello seduta	colore seduta	colore telaio
930	422	marrone	9

## DORIA - POLTRONA

Scocca	Verniciatura		
	serie	fuori serie	cromo
Moplen D5 a vite	48,92	55,90	60,09
Forata in Moplen D6 a vite	51,71	58,70	62,89
Moplen D5 ignifugo Classe M1	57,30	64,28	68,48
Forata in Moplen ignifugo a vite	61,49	68,48	72,68
I02 in polipropilene a scatto	47,52	54,51	58,70
I02 in polipropilene a scatto Classe M1 - ignifugo	58,70	65,68	69,88
SOVRAPPREZZO			
Coppia ganci in plastica per legare le sedie	6,60		



DORIA 2  
Poltrona agganciabile



Coppia ganci in plastica per legare le sedie

## DORIA 2 - POLTRONA AGGANCIABILE

Scocca	Verniciatura		
	serie	fuori serie	cromo
Moplen D5 a vite	54,51	61,49	65,68
Forata in Moplen D6 a vite	55,90	62,89	67,08
Moplen D5 ignifugo Classe M1	62,89	69,88	74,07
Forata in Moplen ignifugo D6 a vite Classe M1	65,68	72,68	76,87
I02 in polipropilene a scatto	51,71	58,70	62,89
I02 in polipropilene a scatto Classe M1	62,89	69,88	74,07

modello poltrona	modello seduta	colore seduta	colore telaio
930 AGG	422	marrone	9

# DORIA 3

Telaio in tubo di acciaio. Gambe tubo ovale 30X15 mm. Piedini neri. Sovrapponibile. Agganciabile. Tavoleta per scrittura.

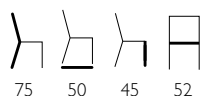

## DORIA 3 - POLTRONA

Sedile e scocca	Verniciatura		
	serie	fuori serie	cromo
Moplen D5 a vite Tavoleta in polipropilene (nero)	79,66	86,65	90,84
Moplen D5 a vite Tavoleta in laminato multistrato (nero-avorio)	82,46	89,44	93,63
Moplen D5 ignifugo Classe M1 Tavoleta in polipropilene (nero)	88,04	95,03	99,23
Moplen D5 ignifugo Classe M1 Tavoleta in laminato multistrato (nero-avorio)	90,84	97,83	102,03
I02 in polipropilene a scatto Tavoleta in polipropilene (nero)	76,87	83,85	88,04
I02 in polipropilene a scatto Classe M1 Tavoleta in polipropilene (nero)	79,66	83,18	90,84
SOVRAPPREZZO			
Sistema aggancio maschio femmina con o senza tavoleta, a scomparsa sotto sedile	20,97		

modello poltrona	modello seduta	colore seduta	colore telaio
930 TAV	422	rosso	I

# VATICANO

Telaio in tubo di acciaio. Gambe tubo ovale 30X15 mm piegato di coltello. Piedini neri. Sovrapponibile.

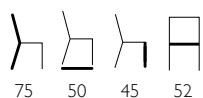

## VATICANO - SEDIA

Sedile e scocca	Verniciatura		
	serie	fuori serie	cromo
Polipropilene, a scatto	50,08	57,07	61,26
Polipropilene ignifuga classe M1, a scatto	55,91	62,89	67,13
SOVRAPPREZZO			
Attacchi ganci braccio tavoleta	16,80		
Bracciolo pressofuso con tavoleta in laminato a scomparsa laterale	60,10		
Ganci in pressofusione	14,00		

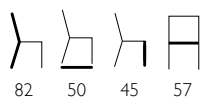

# TECNICA COMFORT

Telaio in tubo di acciaio. Gambe tubo ovale 30X15 mm.  
Piedini neri. Sovrapponibile.



modello sedia	modello seduta	colore seduta	colore telaio
811	404	blu 16	I



modello sedia	modello seduta	colore seduta	colore telaio
811 TAV TL	404	rosso 27	I



modello sedia	modello seduta	colore seduta	colore telaio
811 TAV	404	verde 18	I



modello sedia	modello seduta	colore seduta	colore telaio
811 TAV TL	404	antracite 32	I



Coppia ganci in plastica per legare le sedie

## TECNICA COMFORT

Imbottito in tessuto normale serie ufficio	Verniciatura		
	serie	fuori serie	cromo
Base (senza braccioli e tavoletta)	82,50	89,49	93,68
Con braccio saldato e tavoletta in laminato nera/avorio	138,41	145,39	149,58
Con coppia di braccioli smontabili (perde la sovrapposizione)	116,05	123,03	127,22
Con bracciolo e tavoletta in plastica smontabile nera	148,19	155,17	159,36
Con bracciolo e tavoletta in laminato smontabile nera/avorio	152,37	159,35	163,54
Con braccio pressofuso smontabile e tavoletta in laminato a scomparsa laterale nera/avorio	150,98	157,96	162,15
SOVRAPPREZZO			
Tessuto normale ignifugo		8,38	
Tessuto microfibra ignifugo		19,82	
Coppia ganci in plastica per legare le sedie		6,60	

# NOVAISO

Telaio in tubo di acciaio. Gambe tubo ovale 30X15 mm. Piedini neri. Sovrapponibile.

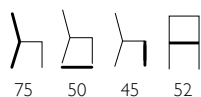

modello sedia	modello seduta	colore seduta	colore telaio
928	426	blu	I



modello sedia	modello seduta	colore seduta	colore telaio
928	426	verde	I



modello sedia	modello seduta	colore seduta	colore telaio
928	426	nero	I



Coppia ganci in plastica per legare le sedie



modello sedia	modello seduta	colore seduta	colore telaio
928	426	rosso	I

## NOVAISO - SEDIA

Sedile e schienale	Verniciatura		
	serie	fuori serie	cromo
Polipropilene normale blu-nero-rosso-verde	55,00	62,00	66,18
Polipropilene ignifugo blu-nero-rosso-verde	63,80	70,79	74,98
SOVRAPPREZZO			
Coppia ganci in plastica per legare le sedie	6,60		

# SIMONA

Telaio in tubo di acciaio. Gambe tubo ovale 30X15 mm. Sedile e schienale in faggio multistrato. Piedini neri. Sovrapponibile.

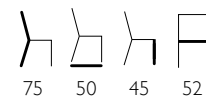

Seduta e schienale in faggio multistrato

modello sedia	modello seduta	colore seduta	colore telaio
935	BRA	P01	9



Seduta e schienale in laminato faggio colore naturale con interposta masonite

modello sedia	modello seduta	colore seduta	colore telaio
935	LAM	P01	9

## SIMONA - SEDIA

Sedile e schienale	Verniciatura		
	serie	fuori serie	Cromo
Faggio multistrati colore naturale con struttura verniciata	88,00	94,66	98,65
Faggio multistrati colore naturale con struttura cromata	98,89	-	-
Laminato masonite	71,50	78,49	82,68
SOVRAPPREZZO			
Coppia ganci in plastica per legare le sedie	6,60		



Coppia ganci in plastica per legare le sedie

# SELENA

Struttura in tubo di acciaio 80×40 mm.  
Sedute con scocche D5-102.  
Basi appoggio regolabili in PVC nero.  
Smontabile.  
Gambe fisse.

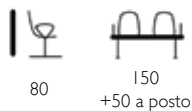

## SELENA

Panca	Verniciatura		
	serie	fuori serie	cromo
Panca fino a 3 posti (COSTO 1 POSTO)	<b>86,65</b>	<b>93,63</b>	<b>97,83</b>
Panca fino a 7 posti (COSTO 1 POSTO)	<b>79,66</b>	<b>86,65</b>	<b>90,84</b>
Piano Nobilitato idrofugo BG. 18 mm. [45x45]	<b>55,90</b>	<b>62,89</b>	<b>67,08</b>
Bracciolo/caduno	<b>13,98</b>	<b>20,97</b>	<b>25,16</b>
Bracciolo+tavoletta in plastica a scomparsa laterale	<b>60,09</b>	<b>67,08</b>	<b>71,28</b>
Bracciolo+tavoletta in laminato a scomparsa laterale	<b>64,28</b>	<b>71,28</b>	<b>75,47</b>

modello	modello seduta	colore seduta	modello piano	colore telaio
946	422	blu av.	(100 grigio) 45x45 cm sp.18 mm	I



## SEDUTA SU TRAVE

modello	modello seduta	colore seduta	modello piano	colore telaio
947	404	rosso 27	(100 grigio) 45x45 cm sp.18 mm	I

# SERENA

Struttura in tubo di acciaio 80×40 mm.  
Seduta e schienale imbottito in tessuto serie ufficio.  
Basi appoggio regolabili in PVC nero.  
Smontabile.  
Gambe fisse.

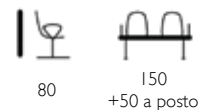

## SERENA - SEDUTA SU TRAVE

Panca	Verniciatura		
	serie	fuori serie	cromo
Panca fino a 3 posti (COSTO 1 POSTO)	<b>116,89</b>	<b>123,03</b>	<b>127,05</b>
Panca fino a 7 posti (COSTO 1 POSTO)	<b>109,26</b>	<b>115,62</b>	<b>119,43</b>
Piano Nobilitato idrofugo BG. 18 mm. [45x45]	<b>55,90</b>	<b>62,89</b>	<b>67,08</b>

## SERENA - RIBALTINA SU TRAVE

Panca	Verniciatura		
	serie	fuori serie	cromo
Panca fino a 3 posti (COSTO 1 POSTO)	<b>160,72</b>	<b>167,71</b>	<b>171,90</b>
Panca fino a 7 posti (COSTO 1 POSTO)	<b>152,33</b>	<b>159,32</b>	<b>163,52</b>
Bracciolo/caduno	<b>13,98</b>	<b>20,97</b>	<b>25,16</b>
Bracciolo + tavoletta plastica a scomparsa laterale	<b>60,09</b>	<b>67,08</b>	<b>71,28</b>
Bracciolo + tavoletta laminato a scomparsa laterale	<b>62,89</b>	<b>69,88</b>	<b>74,07</b>
SOVRAPPREZZO			
Bracciolo imbottito	<b>11,18</b>		



## RIBALTINA SU TRAVE

modello	modello seduta	colore seduta	colore telaio
999 RIB	404	rosso - blu	I

# NOVAISO - SEDUTA SU TRAVE

## PANCA NOVAISO CON GAMBE SELENA

Gambe Novaiso in pressofusione di alluminio / Gambe Selena in acciaio 40x80 mm fisse.  
Seduta e schienale in polipropilene blu e nero.

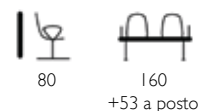

NOVAISO  
SEDUTA SU TRAVE

modello	modello seduta	colore seduta	modello piano	colore telaio
948	426	blu	(100 grigio) 45x45 cm sp.18 mm	9



PANCA NOVAISO  
SU GAMBE SELENA

modello	modello seduta	colore seduta	colore telaio
976	426	nero	6

### NOVAISO/SELENA - SEDUTA SU TRAVE

Panca	Verniciatura		
	serie	fuori serie	Cromo
Panca Novaiso fino a 3 posti (COSTO 1 POSTO)	146,11	153,10	157,29
Panca Novaiso fino a 7 posti (COSTO 1 POSTO)	133,41	140,39	144,58
Panca Novaiso su gambe Selena fino a 3 posti (COSTO 1 POSTO)	126,50	133,49	137,68
Panca Novaiso su gambe Selena fino a 7 posti (COSTO 1 POSTO)	132,00	138,99	143,18
Piano Nobilitato idrofugo BG. 18 mm. [45x45]	55,90	62,89	67,08

## BETA MODULO

Struttura in tubo di acciaio Ø60 mm.  
Seduta con scocca in polipropilene 102 girevole (360° o 90°) con ritorno automatico.  
Basi appoggio regolabili in PVC nero.  
Smontabile.

Lunghezza	Larghezza
185	120



modello	modello seduta	colore seduta	modello piano	colore telaio
910	013 (scocca 102)	blu av.	werzalit 80x120 4Vbianco	1

### BETA - MODULO CON SCOCCA GIREVOLE 360°

Piano e seduta	Verniciatura		
	serie	fuori serie	Cromo
Piano Werzalit [80x120]	600,95	607,94	612,13
Piano Nobilitato idrofugo bordo PVC TORO 18 mm. [80x120]	556,23	563,21	567,40
<b>SOVRAPPREZZO</b>			
BETA SLITTA Seduta con scocca in poliprop. 102 girevole 360° + RITORNO AUTOMATICO + DISPOSITIVO DI ARRETRAMENTO A SCORRIMENTO ORIZZONTALE	195,66		

# APPENDIABITI

Appendiabiti	Verniciatura		
	serie	fuori serie	cromo
<b>PANNELLO SEPARÉ</b>			
Possibilità varianti pannello centrale	469,58	476,56	480,76
<b>POSTO - BARRA A MURO</b>			
Prezzo - 1 posto con ganci di metallo	18,17	25,16	29,35
Prezzo - 1 posto con ganci in plastica col. solo nero	12,57	19,57	23,76
<b>RAGGIO</b>			
Pomoli tondi colore solo nero	116,00	122,98	127,18
<b>RUBINO</b>			
Provvisto di ghiera e vaschetta porta ombrelli	118,79	125,79	129,98
<b>ZAFFIRO</b>			
Con base appoggio in ghisa modello Extrabar	127,18	134,17	138,36
Con base appoggio in ghisa modello Tonda Liscia	194,26	201,25	205,44
Con base appoggio in ghisa modello Tonda Scalini	166,31	173,29	177,49
<b>BISTROT</b>			
Con base appoggio in ghisa modello Bistrot 3 piedi	171,52	178,51	182,70

## Pannello separé

Tubo acciaio 35X35.  
Lunghezza 208 cm. Interasse ganci 20-30 cm.  
Ganci plastica colore nero.  
Ganci metallo stesso colore barra.

modello	colore pannello	colore telaio
PAN SEP	verde	I



Pannello separé		
Lunghezza	Altezza	Profondità
208	182	40

## Posto - Barra a muro

Ganci metallo con barra metallo e/o legno.  
Barra in legno dim. 100x30.  
Profilato acciaio 50X20 abbinata con ganci in plastica.  
Lunghezza variabile interasse ganci 20-30 cm.  
Ganci plastica colore nero.

Lunghezza	150 - 120 a richiesta
Distanza ganci	26



modello	colore
941-051	barra: legno ganci: Fe 9



modello	colore
941-050	barra: 6 ganci: plast. nero

## Raggio

Struttura in tondino.  
Pomoli neri.

Lunghezza	Altezza
70	40

modello	colore telaio
941 RAGGIO	2

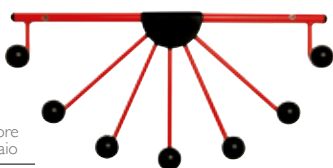

modello	colore telaio
941 RAGGIO	6

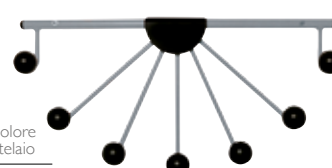

## Rubino

56	210
----	-----

Struttura tubo di acciaio Ø 50 mm.  
Verniciatura a polveri poliestere nel col. nero con portaombrelli + vaschetta.  
Smontabile.

modello	colore telaio
941 RUBINO	I



## Zaffiro/Bistrot

56	210
----	-----

**ZAFFIRO**  
Struttura in tubo di acciaio Ø50 mm  
Base appoggio in ghisa:  
Extrabar, Tonda Liscia, Tonda Scalini  
Smontabile

**BISTROT**  
Struttura in tubo di acciaio Ø50 mm  
Base appoggio in ghisa:  
Bistrot  
Smontabile

modello	colore telaio
941 ZAFFIRO	6

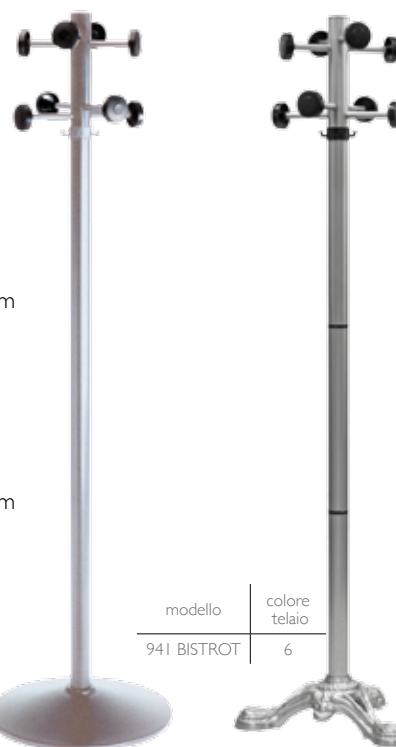

Zaffiro

Bistrot









# OSTUNI NEW

Telaio in tubo di acciaio ovale 40x20 mm.  
Piedini neri. Smontabile.

Piano Slim

Tavolo		Base	
			
Ø60	76	40 lato	73
Ø70		56 diag	
60x60			
70x70			



modello base	modello piano	colore piano	colore gambe
949	002	INOX SAT	6



modello base	modello piano	colore piano	colore gambe
949	009 SLIM 12	31W Wengè	24

## OSTUNI NEW - TAVOLO

Piano	Verniciatura gambe		
	serie	fuori serie	cromo
Werzalit normale [Ø 60]	119,20	126,18	130,37
Werzalit normale [60x60]	131,78	138,77	142,96
Werzalit normale [Ø 70]	131,78	138,77	142,96
Nobilitato idrofugo ABS 18 mm [60x60]	100,10	107,09	111,28
Nobilitato idrofugo BGT/ABS 18 mm [Ø 60]	137,50	144,49	148,68
Nobilitato idrofugo ABS 18 mm [70x70]	140,14	147,12	151,31
Werzalit [70x70]	154,53	161,51	165,70
Werzalit 17 mm [70x70]	154,53	161,51	165,70
SOVRAPPREZZO			
Bordo BGT per piani quadri	11,00		

## OSTUNI NEW - GAMBE





Gambe	Verniciatura gambe		
	serie	fuori serie	cromo
Per piani Ø60 - Ø70 - 60x60 - 70x70	49,50	56,49	71,68



modello base	colore gambe
949	9

# NIZZA NEW

Telaio in tubo di acciaio ovale 40x20 mm.  
Piedini neri. Smontabile.

Tavolo		Base	
			
70x70	76	56 lato 78 diag	73

modello base	modello piano	colore piano	colore gambe
950	009	4W Bianco	I



modello base	modello piano	colore piano	colore gambe
950	009	18W Ciliegio	6



modello base	colore gambe
950	I

## NIZZA NEW - TAVOLO





Piano	Verniciatura gambe		
	serie	fuori serie	cromo
Werzalit normale [Ø 80]	137,37	144,35	148,54
Werzalit normale [70x70]	161,03	168,01	172,21
Nobilitato idrofugo ABS 18 mm [70x70]	121,00	127,99	132,18
SOVRAPPREZZO			
Bordo BGT per piani quadri	11,00		

## NIZZA NEW - GAMBE

Gambe	Verniciatura gambe		
	serie	fuori serie	cromo
Per piani Ø80 - 70x70 - (80x80 max - no ristorazione)	55,00	61,99	66,18

# OLIMPIA SUPER

Telaio in tubo di acciaio ovale 50X25 mm.  
Piedini neri. Smontabile.

Tavolo		Base	
			
80x80 90x90 80x120	76	56 lato 80 diag	73



modello base	modello piano	colore piano	colore gambe
354	010	29W Arancio	6







modello base	colore gambe
354	1

## OLIMPIA SUPER - TAVOLO

Piano	Verniciatura gambe		
	serie	fuori serie	cromo
Werzalit normale [80X80]	202,60	209,58	213,77
Werzalit normale [Ø 90]	198,41	205,39	209,58
Werzalit normale [Ø 120]	253,00	259,99	264,18
Werzalit normale [80X120]	241,74	248,72	252,91
Werzalit normale [90X90]	264,09	271,07	275,26
Nobilitato idrofugo ABS 18 mm [80X80]	154,00	160,99	165,18
SOVRAPPREZZO			
Bordo BGT per piani quadri	11,00		

## OLIMPIA SUPER - GAMBE

Gambe	Verniciatura gambe		
	serie	fuori serie	cromo
Per piani dal Ø90 al Ø120 dal 80x80 al 80x120	77,00	83,99	88,18

Tavolo		Base	
			
Ø60	74	48 lato	72
Ø70		68 diag	
60x60			

# FORGIA

Basamento in tondino forgiato Ø 16 mm. Appoggio 35x35.  
Colonna in tubo di acciaio Ø 60 mm. Fisso.



modello base	colore base
957	I

modello base	modello piano	colore piano	colore base
957	002	30W Faggio Naturale	I

## FORGIA - TAVOLO

Piano	Verniciatura		
	serie	fuori serie	cromo
Werzalit normale [Ø 60]	286,50	293,49	297,68
Werzalit normale [60x60]	299,08	306,06	310,26
Werzalit normale [Ø 70]	299,08	306,06	310,26





## FORGIA - BASE

Base	Verniciatura		
	serie	fuori serie	cromo
Per piani dal 60X60 a 70X70	216,62	230,59	237,59
Per piani dal Ø60 al Ø80 (kg. 9)	216,62	230,59	237,59

# BISTROT - TAVOLO 3 PIEDI

Base e colonna in fusione di ghisa.

Per piani max Ø 70 cm o quadri max lato 60 cm. Smontabile.

Tavolo		Base	
			
Ø60	74	51 lato	71
Ø70		51 diag	
60x60			



modello base	modello piano	colore piano	colore base
958/3P	002	18W Ciliegio	I



modello base	colore base
358/3P + Kit Piastrine	I

cm 108



modello base	colore base
358/3P Fast H.108	I

## BISTROT 3 PIEDI - TAVOLO





Piano	Verniciatura		
	serie	fuori serie	cromo
Verzalit normale [Ø 60]	187,28	194,26	198,45
Verzalit normale [Ø 70]	204,93	211,92	216,12
Verzalit normale [60x60]	199,67	206,66	210,85
Nobilitato idrofugo BGT/ABS 18 mm [Ø 60]	205,39	212,38	216,57

## BISTROT 3 PIEDI - BASE

Base	Verniciatura		
	serie	fuori serie	cromo
Per piani dal Ø60 al Ø70 con kit piastrine+viti	117,39	124,38	128,58
H.108 - Fast per piani Ø60-70	209,64	216,62	220,81

# BISTROT - TAVOLO 4 PIEDI

Base e colonna in fusione di ghisa.  
Adatto a piani tondi Ø 80/90 cm e quadri lato 70/80 cm. Smontabile.

Tavolo		Base	
			
70x70 80x80	73	45 lato 64 diag	71



modello base	modello piano	colore piano	colore base
958/4P	002	42W Palissade	I



modello base	colore base
958/4P	I

## BISTROT 4 PIEDI - TAVOLO





Piano	Verniciatura		
	serie	fuori serie	chromo
Werzalit normale [Ø 80]	270,47	277,45	281,64
Werzalit normale [Ø 90]	304,01	310,99	315,18
Werzalit normale [70x70]	288,63	295,61	299,81
Werzalit normale [80x80]	308,20	315,18	319,37
Nobilitato idrofugo ABS 18 mm [80x80]	259,60	266,59	270,78
SOVRAPPREZZO			
Bordo BGT per piani quadri	10.00		

## BISTROT 4 PIEDI - BASE

Base	Verniciatura		
	serie	fuori serie	chromo
4 razze per piani dal 70X70 al 90X90	182,60	189,59	193,78
H.108 - Fast per piani 70x70 - Ø80 - 4 razze	215,99	222,97	227,16

# JOLLY A

Telaio in tubo di acciaio ovale 40x20 mm.  
Piedini neri. Smontabile.

Tavolo		Base	
			
60x100	76	56x68	73
70x110			
80x120			



modello base	modello piano	colore piano	colore base
971/A	013	4W Bianco	I



modello base	colore base
971A	I





## JOLLY A - TAVOLO

Piano	Verniciatura		
	serie	fuori serie	cromo
Werzalit normale [60x100]	209,58	216,57	220,76
Werzalit normale [70x110]	222,17	229,15	233,34
Werzalit normale [80x120]	241,74	248,72	252,91
Nobilitato idrofugo ABS [80x120]	170,50	177,49	181,68
SOVRAPPREZZO			
Bordo BGT per piani quadri	10,00		

## JOLLY A - BASE

Base	Verniciatura		
	serie	fuori serie	cromo
Per piani da 60X100 - 70X110 - 80X120 max.	77,00	83,99	88,18



Tavolo		Base	
			
60x100	73	82x40	70
70x110			
80x120			

# MADRID

Fiancate in fusione di ghisa.  
Telaio in acciaio piatto. Smontabile.



modello base	modello piano	colore piano	colore base
959	013	4W Bianco	I



modello base	colore base
959	9

## MADRID - TAVOLO



Piano	Verniciatura		
	serie	fuori serie	cromo
Werzalit normale [60x100]	275,58	282,57	286,76
Werzalit normale [70x110]	288,17	295,15	299,34
Werzalit normale [80x120]	307,74	314,72	318,91
SOVRAPPREZZO			
Distanziali per rialzo H. 75 cm.	19,06		

## MADRID - BASE

Base	Verniciatura		
	serie	fuori serie	cromo
Per piani dal 60X100 - 70X110 - 80X120	154,00	160,99	165,18
SOVRAPPREZZO			
Distanziali per rialzo H. 75 cm.	19,06		

# TONDA PIATTA

Basamento in fusione di ghisa Ø 40 cm.  
Colonna in tubo di acciaio Ø 80 mm. Smontabile.

Tavolo		Base	
			
Ø60	76	Ø42	73
70Ø			
80Ø			
60x60			



modello base	modello piano	colore piano	colore base
109	002	37W Antracite	6

modello base	colore base
109	6

## TONDA PIATTA - TAVOLO



Piano	Verniciatura		
	serie	fuori serie	cromo
Werzalit normale [Ø 60]	192,86	199,85	204,04
Werzalit normale [Ø 70]	205,44	212,43	216,62
Werzalit normale [Ø 80]	211,04	218,02	222,21
Werzalit normale [60x60]	205,44	212,43	216,62
Nobilitato idrofugo BGT/ABS 18 mm [Ø 60]	210,98	217,97	222,16

## TONDA PIATTA - BASE

Base	Verniciatura		
	serie	fuori serie	cromo
Per piani dal Ø60 al Ø80	122,98	129,98	134,17

# TONDA ALLUMINIO / TONDA INOX

Basamento in fusione di ghisa Ø 40 cm. Colonna in tubo di alluminio Ø 80 mm. satinato ossidato + crociera alluminio. Smontabile.

Tavolo		Base	
			
Ø60	76	Ø42	73
70Ø			
80Ø			
60x60			



modello base	colore base
110	anodizzato satinato



RIC.ALLUMINIO

modello base	colore base
110 INOX	anodizzato satinato



INOX

modello base	modello piano	colore piano	colore base
110	002	40W Verdino	anodizzato satinato

## TONDA ALLUMINIO TONDA INOX - TAVOLO

Piano	Verniciatura serie
Werzalit normale [Ø 60]	231,40
Werzalit normale [Ø 70]	243,98
Nobilitato idrofugo BGT/ABS 18 mm [Ø 60]	259,35
Sovrapprezzo base INOX	4,40

## TONDA ALLUMINIO / TONDA INOX - BASE

Base	Verniciatura serie
Per piani Ø60 - 60X60 e max Ø70 con piastra alluminio Crocera Alluminio H. 73	162,80
Per piani Ø60 - 60X60 e max Ø70 con piastra INOX satinato Crocera Ghisa H. 73	167,20

# ERIKA

Telaio in tubo di acciaio 25X25 mm. Piedini neri.  
Smontabile solo la piastra.

Tavolo		Base	
Ø60	76	40 lato	73
Ø70		57 diag	
60x60			
70x70			



modello base	modello piano	colore piano	colore base
111	082	Wengè ABS	6



modello base	colore base
111	21

## ERIKA - TAVOLO

Piano	Verniciatura		
	serie	fuori serie	cromo
Werzalit normale [Ø 60]	171,52	178,51	182,70
Werzalit normale [60x60]	184,10	191,08	195,27
Werzalit normale [Ø 70]	184,10	191,08	195,27
Nobilitato idrofugo BGT/ABS 18 mm [Ø 60]	189,64	196,63	200,82
<b>SOVRAPPREZZO</b>			
Bordo BGT per piani quadri	11,00		

## ERIKA - BASE

Base	Verniciatura		
	serie	fuori serie	cromo
Per piani Ø60 - Ø70 - 60X60	101,64	108,63	112,82

# DECÒ FERRO

Telaio in tubo di acciaio Ø 30 mm.  
Piedini neri. Smontabile.



modello base	colore gambe
355	6

modello base	modello piano	colore piano	colore gambe
335	002	24V Alu	24

Tavolo		Base	
Ø60 Ø70 60x60	76	40 lato 56 diag	73

## DECÒ FERRO - TAVOLO

Piano	Verniciatura		
	serie	fuori serie	cromo
Werzalit normale [Ø 60]	<b>129,98</b>	<b>136,96</b>	<b>141,15</b>
Werzalit normale [60x60]	<b>142,55</b>	<b>149,53</b>	<b>153,74</b>
Werzalit normale [Ø 70]	<b>142,55</b>	<b>149,53</b>	<b>153,74</b>
Nobilitato idrofugo BGT/ABS 18 mm [Ø 60]	<b>148,09</b>	<b>155,08</b>	<b>159,27</b>
SOVRAPPREZZO			
Bordo BGT per piani quadri	<b>11,00</b>		

## DECÒ FERRO - GAMBE

Gambe	Verniciatura		
	serie	fuori serie	cromo
Per piani Ø60 - Ø70 - 60X60	<b>60,09</b>	<b>67,08</b>	<b>71,28</b>

# DECÒ 2 ALLARGATO

Telaio in tubo di acciaio Ø 30 mm.  
Piedini neri. Smontabile.



modello base	modello piano	colore piano	colore gambe
336	009	31W Wengè	9

modello base	colore gambe
336	1

Tavolo	
70x70	76

Base	
52 lato 72 diag	73

## DECÒ 2 ALLARGATO - TAVOLO

Piano	Verniciatura		
	serie	fuori serie	cromo
Werzalit normale per DECÒ 2 ALLARGATO [70x70]	<b>178,45</b>	<b>185,44</b>	<b>189,63</b>
SOVRAPPREZZO			
Bordo BGT per piani quadri	<b>11,00</b>		

## DECÒ 2 ALLARGATO - GAMBE

Gambe	Verniciatura		
	serie	fuori serie	cromo
Per piani Ø80 - 70X70 (80X80 max - no ristorazione)	<b>72,42</b>	<b>79,41</b>	<b>83,60</b>

# TONDA LISCIA

Basamento in fusione di ghisa Ø 46 cm.  
Colonna in tubo di acciaio Ø 80 mm. Smontabile.

Tavolo		Base	
	Ø60 76		Ø45 73



modello base	modello piano	colore piano	colore base
955	002	43W Kbana Rouge	23 SAT



modello base	colore base
955	23 SAT

## TONDA LISCIA - TAVOLO

Piano	Verniciatura		
	serie	fuori serie	Cromo
Werzalit normale [Ø 60]	192,86	199,85	204,04
Werzalit normale [Ø 70]	205,44	212,43	216,62
Werzalit normale [Ø 80]	211,04	218,02	222,21
Werzalit normale [60x60]	205,44	212,43	216,62
Werzalit normale [70x70]	229,20	236,18	240,38
Nobilitato idrofugo BGT/ABS 18 mm [Ø 60]	210,98	217,97	222,16
SOVRAPPREZZO			
Colonna in massello di faggio	82,96		

## TONDA LISCIA - BASE

Base	Verniciatura		
	serie	fuori serie	Cromo
Per piani dal Ø 60 al Ø 80	122,98	129,98	134,17
SOVRAPPREZZO			
Colonna in massello di faggio	82,96		

# TONDA SCALINI

Basamento in fusione di ghisa Ø 45 e 60 mm.  
Colonna in tubo di acciaio. Smontabile.



modello base	modello piano	colore piano	colore base
985	002	22W Marmo Bianco	I



Tavolo		Base	
Ø60	76	Ø45	73
Ø70			

modello base	colore base
985	I



modello base	modello piano	colore piano	colore base
985/60	102	Bianco BGT	I

Tavolo		Base	
90x90	76	Ø60	73
Ø120			



modello base	colore base
985/60	23 SAT

## TONDA SCALINI - TAVOLO









Piano	Verniciatura		
	serie	fuori serie	chromo
Werzalit normale [Ø 60]	191,47	198,45	202,64
Werzalit normale [Ø 70]	204,16	211,04	215,23
Werzalit normale [Ø 80]	209,64	216,62	220,81
Werzalit normale [Ø 120]	406,69	413,68	417,87
Werzalit normale [90x90]	396,90	403,89	408,09
Piano Nobilitato idrofugo BGT/ABS 18 mm [Ø 60]	209,58	216,57	220,76
Piano Nobilitato idrofugo BGT/ABS 18 mm [Ø 120]	356,64	363,41	367,82
<b>SOVRAPPREZZO</b>			
Colonna in massello di faggio	82,96		

## TONDA SCALINI - BASE

Base	Verniciatura		
	serie	fuori serie	chromo
Per piani dal Ø 60 al Ø 90 con P.LAM. 25X25 (kg 18)	121,58	128,58	132,77
Per piani dal Ø 100 al Ø 120 con CROC.T 30X20	202,64	209,64	213,83
<b>SOVRAPPREZZO</b>			
Colonna in massello di faggio	82,96		

# QUADRA SCALINI

Basamento in fusione di ghisa 40x40-60x60.  
Colonna tubo 80x80+piastra lamiera. Smontabile.

Tavolo		Base	
			
70x70	80x80	40 lato	73
		56 diag	
Tavolo		Base	
			
90x90	120x120	60 lato	73
		85 diag	



modello base	modello piano	colore piano	colore base
986/46	083	Ciliegio	I



modello base	colore base
986/46	I

## QUADRA SCALINI - TAVOLO

Piano	Verniciatura		
	serie	fuori serie	cromo
Werzalit normale [60x60]	208,23	215,23	219,42
Werzalit normale [70x70]	231,99	238,99	243,18
Werzalit normale [80x80]	251,56	258,54	262,74
Werzalit normale [90x90]	313,05	320,03	324,24
Nobilitato idrofugo ABS 18 mm [80x80]	202,79	209,77	213,96
SOVRAPPREZZO			
Colonna in massello di faggio	82,96		
Bordo BGT per piani quadri	11,00		





## QUADRA SCALINI - BASE

Base	Verniciatura		
	serie	fuori serie	cromo
Per piani dal 60X60 al 90X90 (kg 18)	124,38	131,37	135,56
Per piani dal 90X90 al 120X120 con CROCERA T. 30X20	209,64	216,62	220,81
SOVRAPPREZZO			
Colonna in massello di faggio (solo su base 40x40)	82,96		



# QUADRA LISCIA/QUADRA PIATTA

Basamento in fusione di ghisa quadrato 40X40 e 60x60.  
Colonna in tubo di acciaio 80x80 o Ø 80 mm. Smontabile.

Tavolo		Base	
			
70x70 80x80	76	40 lato 56 diag	73



modello base	colore base
982/40	23 SAT

modello base	colore base
982/40 Piatta	23 Luc

modello base	modello piano	colore piano	colore base
982/40	083	Anticato chiaro	I

## QUADRA LISCIA / QUADRA PIATTA - TAVOLO

Piano	Verniciatura		
	serie	fuori serie	cromo
Werzalit normale [60x60]	208,23	215,23	219,42
Werzalit normale [70x70]	231,99	238,99	243,18
Werzalit normale [80x80]	251,56	258,54	262,74
Werzalit normale [90x90]	313,05	320,03	324,24
Nobilitato idrofugo ABS 18 mm [80x80]	202,79	209,77	213,96
SOVRAPPREZZO			
Colonna in massello di faggio	82,96		
Bordo BGT per piani quadri	11,00		

## QUADRA LISCIA / QUADRA PIATTA - BASE

Base	Verniciatura		
	serie	fuori serie	cromo
Per piani dal 60X60 al 90X90	125,79	132,77	136,96
Per piani dal 90X90 al 120X120	202,64	209,64	213,83
SOVRAPPREZZO			
Colonna in massello di faggio	82,96		

# FAST FOOD



## FAST FOOD EXTRABAR





Tavolo ad un piano o due piani  
con base in lamiera H. 110

Tavolo		Base	
			
Ø60	110	Ø46	108
Ø60-Ø70	76-110		
60x60			
70x70			



## FAST FOOD TONDA SCALINI

Tavolo ad un piano o due piani  
con base in ghisa H. 110

Tavolo		Base	
			
Ø60	110	Ø45	73-108
Ø60-70	76-110		

modello base	colore base
984 Fast	23 SAT

modello base	modello piano	colore piano	colore base
984 Fast	009	42W Palissade	9





modello base	modello piano	colore piano	colore base
985 Fast/2	002+003	24W Alu	1

modello base	colore base
985 Fast	9







## FAST FOOD TONDA LISCIA

Tavolo ad un piano o due piani  
con base in ghisa H. 110

Tavolo		Base	
			
Ø60	110	Ø45	73-108
Ø60-70	76-110		

## FAST FOOD TONDA PIATTA

Tavolo ad un piano con base in  
ghisa H. 110

Tavolo		Base	
			
Ø60	110	Ø45	108

modello base	colore base
988 Fast/2	9

modello base	modello piano	colore piano	colore base
988 Fast	002	18W Ciliegio	1





modello base	modello piano	colore piano	colore base
109 Fast	002	4W Bianco	6

modello base	colore base
109 Fast	9







### FAST FOOD QUADRA INOX

Tavolo ad un piano con base in ghisa ricoperta inox  
Colonna in tubo di acciaio INOX sat. H. 110.

Tavolo		Base	
			
60X60 70X70	110	40 lato 56 diag	108

### FAST FOOD CORSICA 3

Tavolo ad un piano con base in ghisa ricoperta INOX lucido H. 110

Tavolo		Base	
			
Ø60	110	51 lato 51 diag	108







modello base	colore base	modello base	modello piano	colore piano	colore base
952/3-AL Fast	INOX Luc +All. Sat.	952/3-AL Fast	002	44W Kbana Taupe	INOX lucido

modello base	modello piano	colore piano	colore base	modello base	colore base
995 Fast	009	37W Antracite	INOX satinato	995 Fast	INOX satinato







### FAST FOOD QUADRA LISCIA

Tavolo ad un piano con base in ghisa  
H. 110

Tavolo		Base	
			
70X70	110	40 lato 56 diag	108

### FAST FOOD QUADRA SCALINI

Tavolo ad un piano con base in ghisa  
H. 110

Tavolo		Base	
			
Ø60	110	Ø45	108

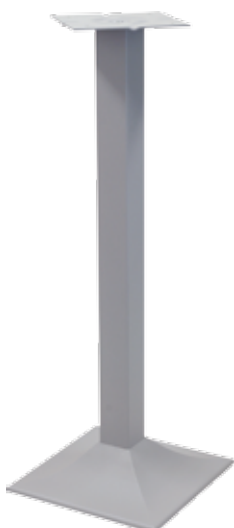

modello base	colore base	modello base	modello piano	colore piano	colore base
982 Fast	9	982 Fast	009	37W Antracite	9

modello base	modello piano	colore piano	colore base	modello base	colore base
986 Fast	009	43W Kbana Rouge	1	986 Fast	1

## FAST FOOD - TAVOLI

Piano	Verniciatura		
	serie	fuori serie	chromo
Lamiera Extrabar 1 piano in Werzalit [Ø 60]	165,17	172,15	176,34
Lamiera Extrabar 1 piano in Werzalit [70x70]	212,18	219,16	223,35
Lamiera Extrabar 2 piani in Werzalit [Ø60-Ø70]	300,49	307,47	311,66
Ghisa Tonda Scalini / Tonda Liscia 1 piano in Werzalit [Ø60]	213,66	220,64	224,83
Ghisa Tonda Scalini / Tonda Liscia 2 piani in Werzalit [Ø60-Ø70]	343,92	350,90	355,09
Ghisa Tonda Piatta 1 piano in Werzalit [Ø60]	213,66	220,64	224,83
Ghisa Quadra Scalini / Quadra Liscia / Quadra Piatta 1 piano in Werzalit [70x70]	250,46	257,44	261,63
Quadra Inox 1 piano in Werzalit [60x60]	279,28	-	-
Quadra Inox 1 piano in Werzalit [70x70]	303,03	-	-
Ghisa ricoperta Inox lucido Corsica3 1 piano in Werzalit [Ø60]	187,50	-	-

## FAST FOOD - BASI

Base	Verniciatura		
	serie	fuori serie	chromo
Lamiera Extrabar per 1 piano [Ø 60]	106,47	113,45	117,64
Lamiera Extrabar per 1 piano [70x70]	211,5	218,48	222,67
Lamiera Extrabar per 2 piani [Ø60-Ø70]	170,51	177,49	181,68
Ghisa Tonda Scalini / Tonda Liscia per 1 piano [Ø60]	143,56	150,54	154,73
Ghisa Tonda Scalini / Tonda Liscia per 2 piani [Ø60-Ø70]	213,93	220,91	225,10
Ghisa Tonda Piatta per 1 piano [Ø60]	143,56	150,54	154,73
Ghisa Quadra Scalini / Quadra Liscia / Quadra Piatta per 1 piano [70x70]	155,42	162,40	166,59
Quadra Inox per 1 piano [da 60x60 a 80x80] stelo tondo Ø8 / quadro 8x8	209,00	-	-
Quadra Inox per 1 piano [da 90x90 a 120x120] stelo tondo Ø8 / quadro 8x8	319,00	-	-
Ghisa ricoperta Inox lucido Corsica3 per 1 piano [Ø60]	117,83	-	-

## FAST FOOD QUADRA PIATTA

Tavolo ad un piano con base in ghisa H. 110



## QUADRA INOX

Basamento in fusione di ghisa 40X40 cm 60x60 cm.  
Colonna in tubo di acciaio INOX SATINATO Ø80 mm e 80x80 mm.  
Piastra copertura base in acciaio INOX SATINATO  
+ crociera in alluminio pressofuso.  
Smontabile.

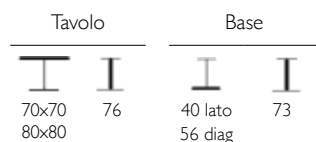

modello base	modello piano	colore piano	colore base
995	010	24W Alu	INOX satinato

## QUADRA INOX - TAVOLO

Piano	Verniciatura
	serie
Werzalit normale [60x60]	269,28
Werzalit normale [70x70]	293,03
Werzalit normale [80x80]	312,60
Werzalit normale [90x90]	374,09
Nobilitato idrofugo ABS 18 mm [80x80]	275,00
Piano vetro satinato sp. 10 mm [70x70]	334,40
<b>SOVRAPPREZZO</b>	
Bordo BGT per piani quadri	11,00

## QUADRA INOX - BASE

Base	Verniciatura
	serie
Per piani 60X60 e max 80x80 (stelo Ø 80 mm. - Stelo quadro 80x80 mm)	187,00
Per piani 60X60 e max 80x80 - H. 108 (Stelo quadro 80x80 mm)	209,00
Per piani dal 90X90 al 120X120	286,00
Per piani 90x90 e 120x120 H. 108	319,00







# QUADRA ALLUMINIO

Basamento in fusione di ghisa 40x40 cm e 45x45 cm.





Colonna in tubo di ALLUMINIO SATINATO ANODIZZATO Ø80 mm.

Piastra copertura base in ALLUMINIO SATINATO ANODIZZATO crociera in alluminio pressofuso.

Smontabile.

Tavolo		Base	
			
70x70	76	40 lato	73
80x80		64 diag	

Tavolo		Base	
			
70x70	76	45 lato	73
80x80		56 diag	
90x90			



modello base	modello piano	colore piano	colore base
995 ALL Stelo Ø80	werzalit 80x80	25W	Alluminio An. Sat.

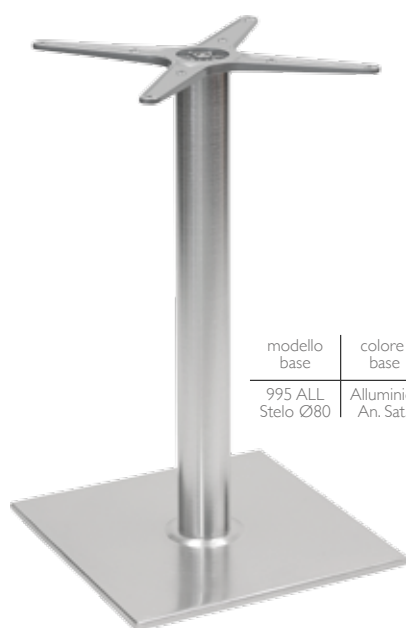

modello base	colore base
995 ALL Stelo Ø80	Alluminio An. Sat.



modello base	colore base
995 ALL Stelo quadro	Alluminio An. Sat.

## QUADRA ALLUMINIO - TAVOLO

Piano	Verniciatura
	serie
Werzalit normale [60x60] base 40x40 cm	252,78
Werzalit normale [70x70] base 40x40 cm	276,53
Werzalit normale [80x80] base 40x40 cm	296,10
Werzalit normale [90x90] base 45x45 cm	390,59
Nobilitato idrofugo ABS 18 mm [80x80] base 40x40 cm	247,50
<b>SOVRAPPREZZO</b>	
Bordo BGT per piani quadri	11,00

## QUADRA ALLUMINIO - BASE

Base	Verniciatura
	serie
Base 40x40 per piani 60X60 e max 70x70	170,50
Base 40x40 per piani 60X60 e max 70x70 H. 108	181,50
Base 45x45 per piani 80X80 e max 90x90	203,50
Base 45x45 per piani 80X80 e max 90x90 H. 108	214,50

# CROCE PIATTA

Basamento in lamiera 8 mm. 43x43 Diag 60 cm.  
Stelo in tubo acciaio Ø 80mm + piastra 25x25 cm lamiera smontabile.

Tavolo		Base	
60x60	76	40 lato	73
70x70		56 diag	
80x80			



modello base	modello piano	colore piano	colore base
160	009	25W Travertino	9

## CROCE PIATTA - TAVOLO

Piano	Verniciatura		
	serie	fuori serie	cromo
Werzalit normale [Ø 60]	251,20	258,18	262,37
Werzalit normale [60x60]	263,78	270,77	274,96
Werzalit normale [70x70]	287,53	294,51	298,71
Werzalit normale [80x80]	307,10	314,08	318,27
Nobilitato idrofugo ABS 18 mm (Tipo B) [80x80]	258,50	265,49	269,68
SOVRAPPREZZO			
Bordo BGT per piani quadri	11,00		

## CROCE PIATTA - BASE

Base	Verniciatura		
	serie	fuori serie	cromo
Per piani dal 60x60 - 70x70 80x80 no ristorazione	181,50	188,49	192,68

modello base	colore base
160	24

# PORTOFINO A / B

Telaio in tubo d'acciaio, Stelo 80x80mm.  
Piedini regolabili. Smontabile.

Tavolo		Base	
70x70	76	75 A	74
80x80		90 B	

## PORTOFINO A/B - TAVOLO

Piano	Verniciatura		
	serie	fuori serie	cromo
Werzalit normale [70x70]	231,99	238,99	243,18
Werzalit normale [80x80]	251,56	258,54	262,74
Werzalit normale (Tipo B) [80x120]	297,68	304,67	308,86
Werzalit normale [90x90]	313,05	320,03	324,24
Nobilitato idrofugo ABS 18 mm [80x80]	202,79	209,77	213,96
Nobilitato idrofugo ABS 18 mm (Tipo B) [80x120]	226,27	233,26	237,45
SOVRAPPREZZO			
Bordo BGT per piani quadri	11,00		

## PORTOFINO AB - TAVOLO

Piano	Verniciatura		
	serie	fuori serie	cromo
Portofino A Per piani dal 70x70 al 90x90	125,79	132,77	136,96
Portofino B Per piani dal 60x100 al 80x120	132,77	139,76	143,95







modello base	modello piano	colore piano	colore base
970	083	nero ABS	1

modello base	colore base
970/B	1

modello base	colore base
970/A	6

# EXTRABAR A/B

Basamento in lamiera Ø 46 (A) Ø 52 (B) cm.  
Colonna in tubo di acciaio Ø 80 mm. Smontabile.

Tavolo		Base	
			
Ø60	76	Ø46 (A)	73
Ø70		Ø52 (B)	
70x70			



modello base	modello piano	colore piano	colore base
984	002	34W Rosso	23 LUC

modello base	modello piano	colore piano	colore base
984	002	41W Avorio/Seringa	cromato



modello base	colore base
984	23 SAT

## EXTRABAR - TAVOLO

Piano	Verniciatura		
	serie	fuori serie	cromo
Werzalit normale [Ø 60]	156,53	163,52	167,71
Werzalit normale [Ø 70]	169,10	176,09	180,28
Werzalit normale [60x60]	169,10	176,09	180,28
Werzalit normale [70x70]	211,04	218,02	222,21
Nobilitato idrofugo [Ø 60] BGT/ABS 18 mm	184,48	191,47	195,66
<b>SOVRAPPREZZO</b>			
Cromatura	49,50		

## EXTRABAR - BASE

Piano	Verniciatura		
	serie	fuori serie	cromo
(A) Per piani dal Ø60 al Ø80	86,65	93,63	97,83
(B) Per piani 80X80 - Ø90	104,82	111,80	116,00

# ARGENTARIO 1/2

Argentario 1: Telaio in tubo acciaio. Base con gambe tubo quadro 35x35 - Smontabile.

Argentario 2: Telaio in tubo acciaio. Base con gambe Ø 40 - Smontabile.

Tavolo		Base (bordo ABS)	
	76		74
60x60		58x58	
70x70		68x68	
80x80		78x88	
90x90		88x88	
80x120		78x118	
80x180		78x178	
80x240		78x238	



modello base	modello piano	colore piano	colore gambe
980/1	086	Faggio naturale ABS	6



modello base	modello piano	colore piano	colore gambe
980/1 Jet H.45	092 80x50	Nero	6

ARGENTARIO 1



modello base	modello piano	colore piano	colore gambe
980/2 Ø40	083	Ciliegio	23 SAT

ARGENTARIO 2



modello base	colore gambe
980/1	9



modello base	colore gambe
980/2	6

## Misure personalizzate

Su richiesta il tavolo Argentario è disponibile in altezze tra i 45 cm e i 110 cm.

Le dimensioni del piano possono essere adattate ad ogni esigenza

## ARGENTARIO 1/2 - TAVOLO

Piano	Verniciatura		
	serie	fuori serie	cromo
Werzalit normale [70x70]	191,47	198,45	202,64
Werzalit normale [80x80]	211,04	218,02	222,21
Werzalit normale [90x90]	280,91	287,89	292,08
Werzalit normale [60x100]	223,61	230,59	234,78
Werzalit normale [70x110]	240,38	247,37	251,56
Werzalit normale [80x120]	262,74	269,73	273,92
Nobilitato idrofugo BL 18 mm. [80x80]	147,95	154,94	159,13
Nobilitato idrofugo BL 18 mm. [80x120]	171,53	178,52	182,71
Nobilitato idrofugo BL 18 mm. [80x180]	216,08	223,29	227,48
Nobilitato idrofugo ABS 18 mm. [80x80]	162,25	169,24	173,43
Nobilitato idrofugo ABS 18 mm. [80x120]	191,33	198,32	202,51
Nobilitato idrofugo ABS 18 mm. [80x180]	243,80	250,79	254,98
Nobilitato idrofugo ABS 18 mm. [80x240]	316,36	323,46	327,54
Laminato ABS 20 mm. [80x80]	210,65	217,64	221,83
Laminato ABS 20 mm. [80x120]	249,63	256,62	260,81
Laminato ABS 20 mm. [80x180]	371,40	378,39	382,58
<b>SOVRAPPREZZO</b>			
Gamba Ø 40 (ARGENTARIO 2)	20,97		
Bordo BGT per piani quadri	11,00		

## ARGENTARIO 1 - GAMBE 35X35 MM

Base ARGENTARIO 1	Misure cm per piano	Verniciatura		
		serie	fuori serie	cromo
Gamba 35x35 mm FERRO	80X80	85,25	92,24	96,43
	60X100	90,84	97,83	102,03
	70X110	95,03	102,03	106,22
	80X120	97,83	104,82	109,01
	80X180	111,80	118,79	122,98
	80X240	132,77	139,76	143,95

### SOVRAPPREZZO

Gambe 35x35 H.108 e H. a richiesta 28,00

## ARGENTARIO 2 - GAMBE Ø 40 MM

Base ARGENTARIO 2	Misure cm per piano	Verniciatura		
		serie	fuori serie	cromo
Gamba Ø 40 mm FERRO	80X80	106,22	113,20	117,39
	60X100	111,80	118,79	122,98
	70X110	116,00	122,98	127,17
	80X120	118,80	125,79	129,98
	80X180	132,77	139,76	143,95
	80X240	153,74	160,72	164,91



# ACCESSORI TAVOLI

## PROLUNGHE TAVOLI

Piano	Verniciatura		
	serie	fuori serie	cromo
Werzalit normale [80x80]	160,72	167,71	171,90
Werzalit normale [80x120]	202,64	209,64	213,83
Werzalit normale [90x90]	225,01	231,99	236,18
Nobilitato idrofugo BL 18 mm [80x80]	100,63	107,61	111,80
Nobilitato idrofugo BL 18 mm [80x120]	114,60	121,58	125,79
Nobilitato idrofugo ABS 18 mm [80x80]	122,94	129,91	134,11
Nobilitato idrofugo ABS 18 mm [80x120]	142,23	149,22	153,41
Multistrato p. sp. 20 mm grezzo S/BORDO [80x80]	107,54	114,52	118,71
Multistrato p. sp. 20 mm grezzo S/BORDO [80x120]	125,73	132,72	137,13
Truciolato grezzo [80x80]	68,48	75,47	79,66
Truciolato grezzo [80x120]	89,44	96,43	100,63
SOVRAPPREZZO			
Prolunghe accostate a Werzalit	11,00		
Kit 4 coppie arresto prolunghe di sicurezza	4,19		
DA PRECISARE IL MODELLO DI TAVOLO A CUI VIENE ABBINATA			

Aste metalliche  
in tubo di acciaio rettangolare 30x20 mm + Piano.

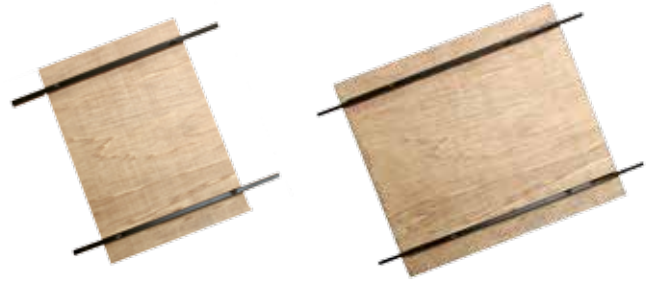

Per tavoli a stelo centrale

Per tavolo Argentario/Delta

modello aste	modello piano	colore piano	colore aste
979/STELO	370	Impr.	I

modello aste	modello piano	colore piano	colore aste
979/ARG	370	Impr.	I

## COPPIA ASTE + ATTACCHI / FORI PER PROLUNGHE

### PER TAVOLI A STELO CENTRALE

Caratteristiche	Verniciatura		
	serie	fuori serie	cromo
COPPIA ASTE 80x80 mm	34,94	41,93	46,12
COPPIA ASTE 80x120 mm	37,73	51,71	58,70
Attacchi per prolunghe n. 4 su 2 lati SMONTATI	13,98	27,95	34,94
Attacchi per prolunghe n. 4 su 2 lati MONTATI	20,97	34,94	41,93

Aste metalliche in tubo di acciaio rettangolare 30x20.  
Attacchi in lamiera sagomata con fori per fissaggio.



Coppia aste prolunga  
per tavoli con stelo centrale

Attacchi per prolunghe per tavoli  
con base a stelo centrale

modello aste	colore aste
979/STELO	I

modello	colore
CAVALLOTTO per stelo	I

### PER TAVOLI ARGENTARIO

Caratteristiche	Verniciatura		
	serie	fuori serie	cromo
COPPIA ASTE 80x80 mm	34,94	41,93	46,12
COPPIA ASTE 80x120 mm	37,73	51,71	58,70
Fori Ø 18 mm sui lati minori	8,38		



Coppia aste prolunga per tavoli  
Argentario I/2.

modello aste	colore aste
979/ARG	I

## PORTASEDIE - TELAIO

Caratteristiche	Verniciatura		
	serie	fuori serie	cromo
Per 1 posto sedia	16,78	30,75	37,73

modello	colore
115/ARG	I

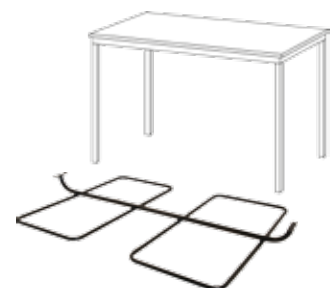

## KIT GAMBE

Gambe	Verniciatura		
	serie	fuori serie	cromo
KIT/980/1 - ARGENTARIO 1 [Ø35x35 kg 4.00]	33,54	40,52	44,73
KIT/980/2 - ARGENTARIO 2 [Ø40, kg 4.50]	40,52	47,52	51,71
KIT/983/1 - DELTA 1 [Ø50x50, kg 7.20]	61,49	68,48	72,68
KIT/983/2 - DELTA 2 [Ø55, kg 6.00]	61,49	68,48	72,68

modello	colore
KIT/980	I



Set gambe per tavoli linea Argentario e Delta.  
Nelle seguenti dimensioni: 35x35, Ø40, Ø55, 50x50.

# DELTA 1/2 - TAVOLO

Telaio in tubo di acciaio 60X20 mm.

DELTA 1: gambe 50X50 mm.

DELTA 2: gambe Ø 55 mm.

Piedini neri.

Smontabile.

Tavolo

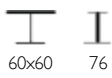

60x60 76  
70x70  
80x80  
90x90  
80x120  
80x180  
80x240

Base (bordo ABS)



58x58 74  
68x68  
78x88  
88x88  
78x118  
78x178  
78x238

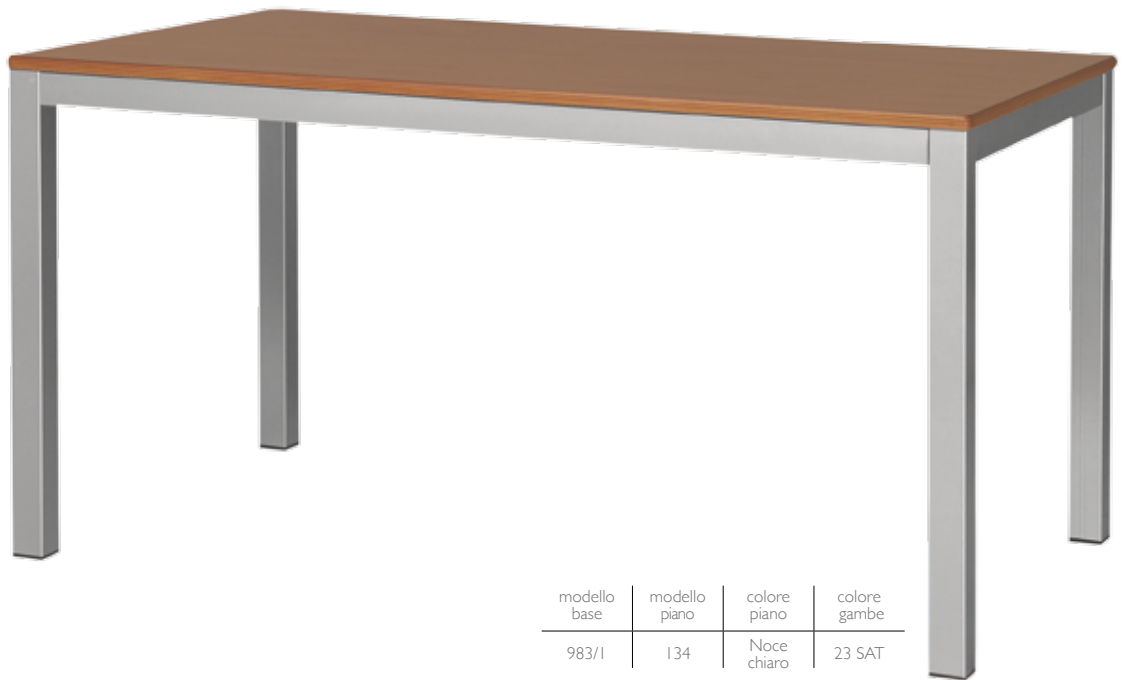

modello base	modello piano	colore piano	colore gambe
983/1	134	Noce chiaro	23 SAT



modello base	modello piano	colore piano	colore gambe
983/1	180	Trasparente Satinato	23 SAT

## DELTA 1/2 TAVOLO





Piano	Verniciatura		
	serie	fuori serie	cromo
Werzalit normale [80X80]	252,96	259,94	264,13
Werzalit normale [80X120]	301,87	308,86	313,05
Werzalit normale [90X90]	325,63	332,62	336,81
NOB.IDR. sp.18 BG.TORO/ABS [80X80]	215,23	222,21	226,40
NOB.IDR. sp.18 BG.TORO/ABS [80X120]	241,78	248,77	252,96
LAM. sp. 22 BORDO ABS. MILLER.IGHE/ALL.MET. [80X80]	302,51	309,50	313,69
FISSO LAM. sp. 22 BORDO ABS. MILLER.IGHE/ALL.MET. [80X120]	376,83	383,82	388,01
ALLUNGA LAM. sp. 22 BORDO ABS. MILLER.IGHE/ALL.MET. [80X40]	175,33	-	-
VETRO TEMPERATO TRASPARENTE sp. 10 mm FISSO [80X120]	381,15	388,14	392,33
VETRO TEMPERATO SATINATO sp. 10 mm FISSO [80X120]	430,71	437,69	441,88

### Misure personalizzate

Su richiesta il tavolo Delta è disponibile in altezze tra i 45 cm e i 110 cm. Le dimensioni del piano possono essere adattate ad ogni esigenza.

# DELTA 1/2 LIBRO - TAVOLO ALLUNGABILE

Telaio in tubo di acciaio 60X20 mm.  
DELTA 1: gambe 50X50 mm. / DELTA 2: gambe Ø 55 mm. Piedini neri.  
Smontabile.





Tavolo		Base (bordo ABS)	
			
80x120/160 80x180/220	76	78x118 78x178	74



DELTA 1 ALLUNGABILE

modello base	modello piano	colore piano	colore gambe
983/1 ALLUNGA	134 ALLUNGA	Noce chiaro	23 SAT

DELTA 2 LIBRO (aperto)

Tavolo		Base (bordo ABS)	
			
80x80/160 90x90/180	76	78x88 88x88	74



modello base	modello piano	colore piano	colore gambe
983/2 LIBRO	133 LIBRO	Noce chiaro	23 SAT



DELTA 2 LIBRO (chiuso)



## DELTA 1/2 LIBRO - TAVOLO ALLUNGABILE

Piano	Verniciatura		
	serie	fuori serie	chromo
LIBRO LAM. sp. 22 BORDO ABS. MILLERIGHE/ALL.MET. [80X80+80X160]	474,89	481,87	486,06
LAM. sp. 22 B. "ALLUNGATO" ABS. MILLERIGHE/ALL.MET. [90X90 all. 90X180]	502,04	509,02	513,21
LAM. sp. 22 B. "ALLUNGATO" ABS. MILLERIGHE/ALL.MET. [80X120 all. 80X160]	434,40	441,38	445,57

# DELTA 1/2 - BASE

Telaio in tubo di acciaio 60X20 mm. DELTA 1: gambe 50X50 mm. / DELTA 2: gambe Ø 55 mm. Piedini neri. Smontabile.

Base (bordo ABS)

	
58x58	74
68x68	
78x88	
88x88	
78x118	
78x178	
78x238	

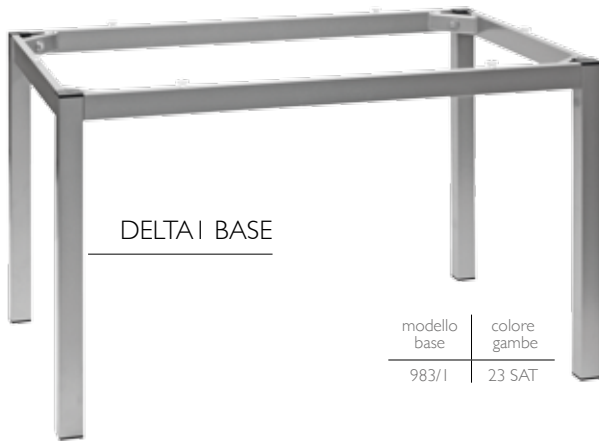

DELTA 1 BASE

modello base	colore gambe
983/1	23 SAT

DELTA 2 BASE  
Predisposto per ALLUNGA



modello base	colore gambe
983/2 LIBRO	6





## DELTA 1 (gambe 50x50 mm) / DELTA 2 (gambe Ø55) - BASE

Base	Verniciatura		
	serie	fuori serie	cromo
80X80	127,18	134,17	138,36
90X90	138,36	145,34	149,53
60X100	134,17	141,15	145,34
70X110	138,36	145,34	149,53
80X120	136,96	143,95	148,14
80X180	153,74	160,72	164,91
80X240	181,69	188,67	192,86
SOVRAPPREZZO			
Predisp. allunga laterale	63,53		
Predisp. piano a libro + (mont. al/libro + € 14,80)	48,29		
Gambe 50x50 H.108 e H. a richiesta (DELTA 1)	30,00		

La base DELTA 1-2 viene prodotta con misure a richiesta con aumento +10% rif. prezzo mis. superiore

# DELTA KIT 1/2

Struttura in tubo di acciaio.  
DELTA KIT 1: gambe 60x60 mm.  
DELTA KIT 2: gambe Ø 60 mm.  
Piedini neri regolabili.  
Smontabile

Tavolo		Base	
			
70x70	76	64x64	74
80x80		74x74	
90x90		84x84	
80x120		74x114	

## DELTA KIT 1 - GAMBE

Base	Verniciatura		
	serie	fuori serie	cromo
DELTA KIT 1 Gambe 60x60 mm. verniciate	117,81	121,28	125,90
DELTA KIT 1 Gambe 60x60 mm cromate	180,18	-	-
DELTA KIT 2 Gambe Ø60 MM verniciate	76,87	83,85	88,04
DELTA KIT 2 Gambe Ø60 MM cromate	89,57	-	-

## DELTA KIT - TAVOLO

Piano	Verniciatura		
	serie	fuori serie	cromo
Werzalit normale 80x80 cm	208,23	215,23	219,42
Werzalit normale 80x120 cm	247,37	254,35	258,54
Werzalit normale 90x90 cm	269,73	276,72	280,91
SOVRAPPREZZO			
Gambe CROMATE	12,71		



modello base	modello piano	colore piano	colore gambe
987/2	010	24W Alu	cromato

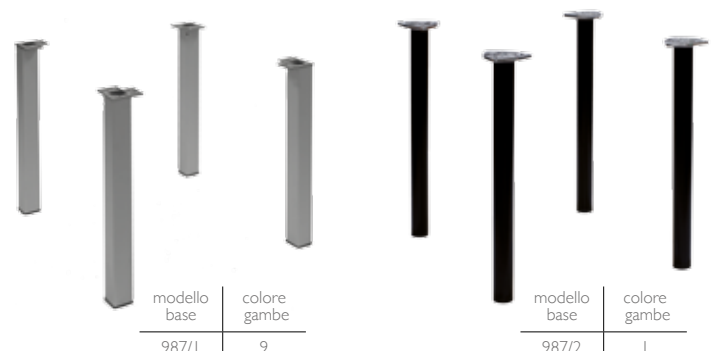

modello base	colore gambe
987/1	9

modello base	colore gambe
987/2	1

# JOKER A

Telaio in tubo di acciaio ovale 40X20 mm.  
Piedini neri. Pieghevole.

Tavolo

Base



80x120  
80x160  
80x180  
80x240

76

62 lato  
lung. varia

74



modello base	modello piano	colore piano	colore base
960	086	noce scuro	I

## JOKER A - TAVOLO

Piano	Verniciatura		
	serie	fuori serie	cromo
Werzalit normale [70x110]	286,50	293,49	297,68
Werzalit normale [80x120]	306,06	313,05	317,24
Nobilitato idrofugo BGT/ABS [80x120]	245,84	252,82	257,02
Laminato sp. 20 mm BGP/BGT/ABS [80x120]	293,14	300,12	304,32
Nobilitato idrofugo BGT/ABS [80x150/160]	284,34	291,32	295,52
Nobilitato idrofugo BGT/ABS (s/aste rinf.) [80x180]	295,34	302,32	306,52
Laminato BGP/BGT/ABS (s/aste rinf.) [80x180]	400,94	407,92	412,12
Mult. pioppo grezzo sp. 20 mm BGP/BGT [80x120]	262,34	269,32	273,52
Mult. pioppo grezzo sp. 20 mm BGP/BGT [80x150/160]	289,84	296,82	301,02
Mult. pioppo grezzo sp. 20 mm BGP/BGT (s/aste rinf.) [80x180]	295,34	302,32	306,52
Mult. pioppo grezzo sp. 20 mm BGP/BGT (c/aste rinf.) [80x240]	340,44	347,42	351,62
<b>SOVRAPPREZZO</b>			
Coppia aste rinforzo 30X20 cm consigliabile per lungh. da 180 cm in su	30,75		



modello base	colore base
960	I

## JOKER A - BASE

Base	Verniciatura		
	serie	fuori serie	cromo
Per piani dal 80x120 al 80x240	129,98	136,96	141,15
<b>SOVRAPPREZZO</b>			
Coppia aste rinforzo 30X20 cm consigliabile per lunghezze piano sup. 180 cm.	30,75		
Montaggio della base sul piano viteria inclusa	22,36		

## CARRELLO PORTA TAVOLI JOKER A e JOKER 4 GAMBE

Telaio di tubo di acciaio 30x20 mm.  
Ruote Pivotanti in metallo e gomma (di cui due con freno).  
Maniglia di trascinamento.



Carrello Joker A - Colore struttura: I

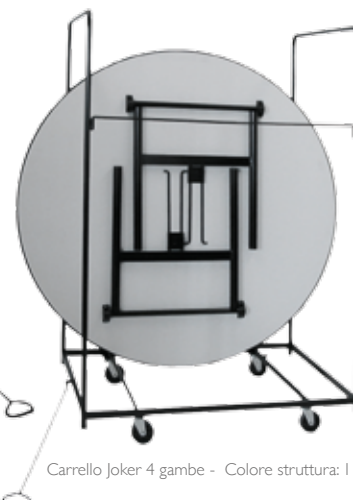





Carrello Joker 4 gambe - Colore struttura: I

Carrello portavoli		Verniciatura		
		serie	fuori serie	cromo
Capienza n. 10 Tavoli disposti orizzontalmente sovrapposti	80x120	366,16	373,14	377,34
Capienza n. 8 Tavoli disposti verticalmente	Ø 180	377,34	384,33	388,52

# JOKER 4 GAMBE

Telaio in tubo di acciaio Ø40 mm. Gambe Gambe Ø 40mm. Piedini neri.  
Pieghevole. Spessore del tavolo chiuso 7 cm. Dispositivo bloccaggio.

Tavolo		Base	
			
Ø120	76	61	74
80x120		87 allargato	
80x160			
80x180			
80x200			
80x240			
Ø140			
Ø160			
Ø180			



modello base	modello piano	colore piano	colore gambe
962	105	noce scuro	1

## JOKER 4 GAMBE -TAVOLO

Piano	Verniciatura		
	serie	fuori serie	chromo
Werzalit normale [Ø120]	338,21	345,19	349,39
Werzalit normale [80x120]	299,08	306,06	310,26
Nobilitato idrofugo BGT/ABS [80x120]	238,84	245,84	250,03
Nobilitato idrofugo BGT/ABS [80x150]	266,34	273,33	277,52
Nobilitato idrofugo BGT/ABS [80x180] (s/aste rinf.)	288,34	295,33	299,52
Nobilitato idrofugo BGT sp. 18 mm [Ø120]	288,34	295,33	299,52
Nobilitato idrofugo BGT sp. 18 mm [Ø140]	326,84	333,83	338,02
Nobilitato idrofugo BGT sp. 18 mm [Ø160]	332,34	339,33	343,52
Nobilitato idrofugo BGT sp. 18 mm [Ø180]	351,73	358,71	362,90
Mult. pioppo grezzo BGT sp. 20 mm [Ø120]	332,34	339,33	343,52
Mult. pioppo grezzo BGT sp. 20 mm [Ø140]	367,54	374,53	378,72
Mult. pioppo grezzo BGT sp. 20 mm [Ø160]	387,34	394,33	398,52
Mult. pioppo grezzo BGT sp. 20 mm [Ø180]	406,04	413,03	417,22
Mult. pioppo grezzo BGP/BGT sp. 20 mm [80x120]	255,34	262,33	266,52
Mult. pioppo grezzo BGP/BGT sp. 20 mm [80x150/160]	282,84	289,83	294,02
Mult. pioppo grezzo [80x180] BGP/BGT 20 mm (s/aste rinf.)	288,34	295,33	299,52
Mult. pioppo grezzo [80x200] BGP/BGT 20 mm (s/aste rinf.)	322,44	329,43	333,62
Mult. pioppo grezzo [80x240] BGP/BGT 20 mm (c/aste rinf.)	333,44	340,43	344,62

### Misure personalizzate

Su richiesta il tavolo Joker è disponibile in altezze tra i 74 cm e i 110 cm.

Le dimensioni del piano possono essere adattate ad ogni esigenza.



modello base	colore gambe
962	1

## JOKER 4 GAMBE Ø 40 - BASE





Base	Verniciatura		
	serie	fuori serie	chromo
Per piani dal Ø120 a Ø160	122,98	129,98	134,17
Per piani dal 80x120 al 80x240	122,98	129,98	134,17
<b>SOVRAPPREZZO</b>			
Con piano dal Ø160 al Ø180 gamba allargata o alt. diversa	8,38		
Coppia aste rinforzo 30x20 consigliabile per lunghezze piano sup. 180 cm.	30,75		
Montaggio della base sul piano viteria inclusa	22,36		

La base joker 4 gambe viene prodotta con larghezze inferiori a cm 61 e superiori a cm. 87(vers. allargata) con aggiunta sovrapprezzo. Così vale per altezze inferiori a 74 cm e superiori sino a 108 cm

# JOKER 4 GAMBE PIANO LEGNO

Telaio in tubo di acciaio Ø40 mm. Gambe Gambe Ø 40mm. Piedini neri. Pieghevole. Spessore del tavolo chiuso 7 cm. Dispositivo bloccaggio.

modello base	modello piano	colore piano	colore gambe
962 LEGNO	525	Abete naturale	I

Tavolo		Base	
			
80x220	76	61	74
87 allargato			





## JOKER 4 GAMBE PIANO LEGNO - TAVOLO

Piano	Verniciatura		
	serie	fuori serie	chromo
Abete col. naturale 27 mm [70X220]	332,20	339,19	343,38
Abete col. naturale 27 mm [80X220]	343,20	350,19	354,38

# MARTE

Tavolo pieghevole rotondo H.74.  
Piano in polietilene soffiato  
- gambe in tubolare Ø 28mm  
- Martellato grigio.

	
Ø123	74
Ø160	
Ø183	

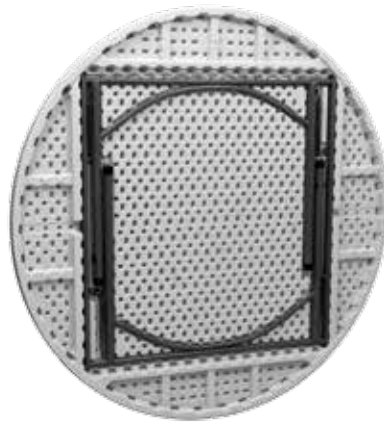

## MARTE - TAVOLO

Piano	Verniciatura
	serie
Polietilene soffiato Ø 123	118,80
Polietilene soffiato Ø 160	237,00
Polietilene soffiato Ø 183	270,20

modello base	modello piano	colore piano	colore gambe
964	polietilene soffiato Ø180	grigio	I3



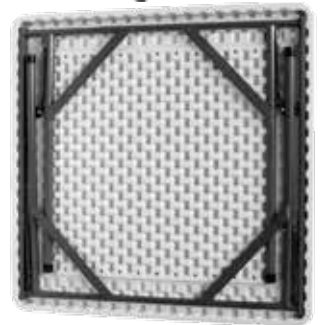

Tavolo pieghevole rettangolare H.74.  
Piano in polietilene soffiato - gambe in tubolare Ø 28mm - Martellato grigio.



modello base	modello piano	colore piano	colore gambe
965	polietilene soffiato 184x76,5	grigio	I

## GIOVE - TAVOLO

Piano	Verniciatura
	serie
Polietilene soffiato [153x76,5]	110,20
Polietilene soffiato [184x76,5]	120,00
Polietilene soffiato [210x76,5]	170,00
Polietilene soffiato [88x88]	104,50

	
88x88	74,5
153x76,5	
184x76,5	
210x76,5	

modello base	modello piano	colore piano	colore gambe
965	polietilene soffiato 88x88	grigio	I3

# SEDIE E TAVOLI IN LEGNO

Assortimento con offerte su richiesta



Venezia paglia



Venezia massello



Friuli paglia



Friuli massello



Cleo paglia



Rondó sedia



Rondó poltrona



Milano sedia



Irina sedia



Irina imbottita



Elena legno



Pisa paglia Ø44



Spillo tavolo



Spada tavolo





# RICAMBI E ACCESSORI

## SEDILI - SCOCCHHE

Codice	Caratteristiche	Euro
SEDILE E SCHIENALE PORTOBELLO 000-401	Coppia Sedile + Schienale in POLIPROPILENE colori BIANCO - ARANCIO - VERDE - BLU	13,98
SCOCCA D5 000-442	Monoscocca piena in MOPLEN avitata nei colori di serie	15,39
SCOCCA D6 000-423	Monoscocca forata in MOPLEN avitata nei colori di serie	18,18
SCOCCA 102 000-425	Monoscocca piena in POLIPROPILENE a scatto	16,78
SCOCCA D5 IGN 000-427	Monoscocca piena in MOPLEN IGNIFUGO avitata nei colori di serie	23,77
SCOCCA D6 IGN 000-428	Monoscocca forata in MOPLEN IGNIFUGO avitata	26,69
SCOCCA 102 IGN 000-430	Monoscocca piena in POLIPROPILENE a scatto nei colori di serie	25,15
NOVAISO NORM 000-426	Sedile e Schienale in POLIPROPILENE sedile avitato schienale inserito	17,16
NOVAISO IGN 000-426	Sedile e Schienale in POLIPROPILENE sedile avitato schienale inserito	25,55
SCOCCA PULL	Scocca in POLIPROPILENE per Cristina sedia, a vite	20,00
SCOCCA S18	Scocca in POLIPROPILENE per S18 sedia agganciabile, a vite	19,00
SCOCCA S18 IGN	Scocca in POLIPROPILENE IGNIFUGA per S18 sedia agg. a vite	27,00

## SEDUTE MATERIALE PLASTICO NORMALE, IGNIFUGO, LAMIERA, LEGNO

Codice	Caratteristiche	Euro
000-442-F	Sedile FINTA PAGLIA a vite Ø 40 cm per BISTROT - JESSICA	11,55
000-452	Sedile FINTA PAGLIA a Scatto Ø 40 cm per BISTROT - JESSICA	5,59
000-443	Sedile TEX PLAST Ø 40 a scatto per modelli con seduta rotonda	13,86
000-443	Sedile VERA PAGLIA Ø 40 cm per BISTROT - JESSICA	26,55
000-446	Sedile RIGATO PIENO a Scatto. Sagomato Trapezio per DIANA	6,99
000-447	Sedile FINTA PAGLIA a Scatto con Anello. Sagomato Trapezio per DIANA	8,64
000-454	Sedile FIORE a Scatto Ø 40 cm per BISTROT - JESSICA	5,59
000-460	Sedile RIGATO a Scatto UNILEGNO Ø 40 cm per BISTROT - JESSICA	6,99
000-458	Sedile LAMIERA Saldato Ø 40 cm per BISTROT - JESSICA	16,78
000-459	ANELLO NERO a Scatto Ø 40 cm per BISTROT - JESSICA	2,79
000-459 MET	ANELLO GRIGIO MET. a Scatto Ø 40 cm per BISTROT - JESSICA - CINZIA - DIANA	3,82
000-457	ANELLO DIANA NERO Sagomato Trapezio per DIANA	3,30
000-457 MET	ANELLO GRIGIO MET. Sagomato Trapezio per CINZIA - DIANA	4,58
000-444 IGN	Sedile FINTA PAGLIA IGNIFUGO a Scatto Ø 40 cm per BISTROT - JESSICA	11,18
000-457 IGN	ANELLO DIANA NERO IGNIFUGO Sagomato Trapezio per DIANA	4,70
000-447 IGN	Sedile FINTA PAGLIA IGNIFUGO a Scatto Sagomato Trapezio + Anello per DIANA	12,24
000-459 IGN	ANELLO NERO IGNIFUGO a Scatto Ø 40 cm per BISTROT - JESSICA	4,19
000-476	Sedile FAGGIO MULTISTRATO Ø 40 cm Spessore 16 mm	32,14
000-477	Sedile FAGGIO MULTISTRATO Ø 35 cm Spessore 16 mm	32,14
000-478	Sedile FAGGIO LEGNO TAMB. Trapezio per sedia MILANO	34,31
000-479	Schienale FAGGIO MASSELLO per sedia Milano	21,60
000-480	Schienale FAGGIO MASSELLO per sedia JESSICA (Ø 35 cm)	25,16
000-481	Schienale FAGGIO MASSELLO per POLTRONA JESSICA (Ø 35 cm)	29,35

## SEDUTE IN LAMINATO

Codice	Caratteristiche	Euro
000-482	Sedile e Schienale LAMINATO. Colori di serie (Coppia) Laretta/Asilo	16,16
000-482	Sedile e Schienale LAMINATO. Colori di serie (Coppia) Laretta New Design	16,16

## DOGHE RESINA VALENTINA

Codice	Caratteristiche	cm	Euro
000-521	Antiurto. Anima in Metallo	120	33,54
000-522	Antiurto. Anima in Metallo	150	37,73

## DOGHE ABETE GIADA

Codice	Caratteristiche	cm	Euro
000-523	Naturale con Impregnante	120	23,76
000-524	Naturale con Impregnante	150	27,95

## SEDUTE FINTA PELLE

Codice	Caratteristiche	Euro
000-461-A	Sedile Imbottito su supporto Truciolare, spessore 18 mm Ø 40 cm	30,00
000-462	Sedile Imbottito Con Anello Ø 40 cm per BISTROT - JESSICA	18,17
000-463	Sedile Imbottito. Sagomato Trapezio per SABINA 90	19,57
000-464	Sedile Imbottito. Sagomato Trapezio per ADRIA	28,00
000-465	Schienale Imbottito. Sagomato per ADRIA	26,55
000-466	Schienale Imbottito. Sagomato per BISTROT COMFORT	27,95
000-461	Sedile Imbottito Ø 35 cm per SGABELLO LIBERTY	20,97
000-469	Sedile Imbottito Con Anello a Scatto. Sagomato Trapezio per DIANA	23,76
000-470	Sedile Imbottito. Quadrato per CINZIA	19,57
000-472	Coppia Sedile/Schienale Imbottiti per LAURETTA	18,17
000-461	Sedile Imbottito Ø 32 cm spessore 10 cm per IRIS SGABELLO	72,68
000-474	Coppia Sedile/Schienale con Sedile Imbottito per SELENIA	93,63
000-502-A	Schienale Cicala Comfort. Sagomato per CICALA	34,94
CUBO	Sedile Imbottito su supporto Truciolare, spessore 18 mm 36x36 cm	30,00

**SEDUTE FINTA PELLE IGNIFUGA 000-000 IGN CON FINTA PELLE IGNIFUGA SOVRAPPREZZO + 30% SUL LISTINO**

## SEDUTE TESSUTO

Codice	Caratteristiche	Euro
000-481-A	Sedile Imbottito su supporto Truciolare, spessore 18 mm Ø 40 cm	23,00
000-482-A	Sedile Imbottito Con Anello Ø 40 cm per BISTROT - JESSICA	19,57
000-483-A	Sedile Imbottito. Sagomato Trapezio per SABINA 90	20,97
000-484-A	Sedile Imbottito. Sagomato Trapezio per ADRIA	28,00
000-485-A	Schienale Imbottito. Sagomato per ADRIA	26,55
000-486-A	Schienale Imbottito. Sagomato per BISTROT COMFORT	29,35
000-461-A	Sedile Imbottito Ø 35 cm per SGABELLO LIBERTY	16,78
000-489-A	Sedile Imbottito Con Anello. Sagomato Trapezio per DIANA	23,76
000-490-A	Sedile Imbottito. Quadrato per CINZIA	19,57
000-461-A	Sedile Imbottito Ø 32 cm spessore 10 cm per IRIS SGABELLO	75,47
000-502-A -S	Schienale Cicala Comfort. Sagomato per CICALA	39,13

**SEDUTE TESSUTO B 000-000-B CON TESSUTO TIPO B SOVRAPPREZZO +30% SUL LISTINO  
SEDUTE TESSUTO IGNIF CON TESSUTO IGNIFUGO SOVRAPPREZZI +30% SUL LISTINO**

## PIANI WERZALIT NORMALI (MONOCOLORE)

Codice	Piani	cm	Euro
000-001	Werzalit normale per sedia	Ø 40	45,74
000-002	Werzalit normale SENZA PIASTRINE	Ø 60	58,70
000-003	Werzalit normale SENZA PIASTRINE	Ø 70	71,28
000-004	Werzalit normale SENZA PIASTRINE	Ø 80	76,87
000-005	Werzalit normale SENZA PIASTRINE	Ø 90	110,41
000-007	Werzalit normale SENZA PIASTRINE	Ø 120	165,00
000-008	Werzalit normale SENZA PIASTRINE	60x60	71,28
000-009	Werzalit normale SENZA PIASTRINE	70x70	95,03
000-010	Werzalit normale SENZA PIASTRINE	80x80	114,60
000-014	Werzalit normale SENZA PIASTRINE	90x90	176,09
000-011	Werzalit normale SENZA PIASTRINE	60x100	121,58
000-012	Werzalit normale SENZA PIASTRINE	70x110	134,17
000-013	Werzalit normale SENZA PIASTRINE	80x120	153,74

**000-SPEC SOVRAPPREZZO COLORI FUORI SERIE +30%  
000-KIT SOVRAPPREZZO PIASTRINE SMONTATE+ 9,00 €  
000-KITPM SOVRAPPREZZO PIASTRINE MONTATE SUL PIANO+ 10,00 €**

## PIANO: LAMINATO STRATIFICATO SPESSORE 12 MM - HPL - BORDO FRESATO SEMITORO

Codice	Caratteristiche	cm	Euro
000-STRAT	Stratificato - Bicolore Wenghé/Noce	59x59	151,80
000-STRAT	Stratificato - Bicolore Wenghé/Noce	69x69	177,10
000-STRAT	Stratificato - Bicolore Wenghé/Noce	80x80	223,30
000-STRAT	Stratificato - Bicolore Wenghé/Noce	80x120	295,90

## PIANI INOX FIORETTATI

Codice	Piani	Misure (cm)	Euro
000-002 INOX FIOR	Inox Fiorettato SENZA PIASTRINE	Ø 60	77,39
000-003 INOX FIOR	Inox Fiorettato SENZA PIASTRINE	Ø 70	102,80
000-004 INOX FIOR	Inox Fiorettato SENZA PIASTRINE	Ø 80	121,28
000-008 INOX FIOR	Inox Fiorettato SENZA PIASTRINE	60x60	81,20
000-009 INOX FIOR	Inox Fiorettato SENZA PIASTRINE	70x70	103,95
000-010 INOX FIOR	Inox Fiorettato SENZA PIASTRINE	80x80	121,86

000-KIT SOVRAPPREZZO PIASTRINE SMONTATE+ 9,00 €  
000-KITPM SOVRAPPREZZO PIASTRINE MONTATE SUL PIANO+ 10,00 €

## PIANO NOBILITATO ANTIGRAFFIO IDROFUGO E NORMALE: SPESSORE 18/25 MM - BORDO TORO NERO O ABS COLORE COME PIANO

Codice	Caratteristiche	cm	Euro	
			ABS	BGT
000-080	Nobilitato - Antigraffio - Idrofugo/Normale	Ø 60	77,00	77,00
000-079	Nobilitato - Antigraffio - Idrofugo/Normale	Ø 70	88,00	88,00
000-078	Nobilitato - Antigraffio - Idrofugo/Normale	Ø 80	99,00	99,00
000-091	Nobilitato - Antigraffio - Idrofugo/Normale	Ø 90	104,50	104,50
000-101	Nobilitato - Antigraffio - Idrofugo/Normale	Ø 100	137,50	137,50
000-102	Nobilitato - Antigraffio - Idrofugo/Normale	Ø 120	143,00	143,00
000-087	Nobilitato - Antigraffio - Idrofugo/Normale	Ø 110	143,00	143,00
000-103	Nobilitato - Antigraffio - Idrofugo/Normale	Ø 140	181,50	181,50
000-104	Nobilitato - Antigraffio - Idrofugo/Normale	Ø 150	187,00	187,00
000-105	Nobilitato - Antigraffio - Idrofugo/Normale	Ø 160	187,00	187,00
000-106	Nobilitato - Antigraffio - Idrofugo/Normale	Ø 180	198,00	198,00
000-107	Nobilitato - Antigraffio - Idrofugo/Normale	Ø 200	245,00	245,00
000-081	Nobilitato - Antigraffio - Idrofugo/Normale	60x60	39,60	50,60
000-082	Nobilitato - Antigraffio - Idrofugo/Normale	70x70	55,00	66,00
000-083	Nobilitato - Antigraffio - Idrofugo/Normale	80x80	66,00	77,00
000-077	Nobilitato - Antigraffio - Idrofugo/Normale	90x90	71,50	82,50
000-086	Nobilitato - Antigraffio - Idrofugo/Normale	80x120	82,50	93,50
000-076	Nobilitato - Antigraffio - Idrofugo/Normale	80x130	99,00	110,00
000-075	Nobilitato - Antigraffio - Idrofugo/Normale	80x150	110,00	121,00
000-074	Nobilitato - Antigraffio - Idrofugo/Normale	80x160	121,00	132,00
000-088	Nobilitato - Antigraffio - Idrofugo/Normale	80x180	121,00	143,00
000-088-B	Nobilitato - Antigraffio - Idrofugo/Normale	80x200	165,00	187,00
000-089	Nobilitato - Antigraffio - Idrofugo/Normale	80x240	172,70	209,00
000-092	Nobilitato - Antigraffio - Idrofugo/Normale	80x50	52,80	63,80
000-100	Nobilitato - Antigraffio - Idrofugo/Normale	45x45	38,50	44,00
000-MON	Nobilitato - Antigraffio - Idrofugo/Normale	45x70	44,00	49,50

### SOVRAPPREZZO

Piani ABS sp 36 mm	+100%
Piani ABS sp 25 mm	+15%
Piano nob. Colore Vintage e serie SMART	+30%
Piani ignifughi solo bianco sp. 18/19 mm	+25%

## PIANO MEDIUM DENSITY CON MEZZELUNE

Codice	Caratteristiche	cm	Euro
000-111	Medium Density	90x90	50,00
000-112 PIANO	Medium Density	80x80 + n. 4 mezzelune = Ø 114	349,39

## PIANO LAMINATO: SPESSORE 22 MM BORDO ABS MILLERIGHE

Codice	Caratteristiche	Misure (cm)	Euro
000-131	Laminato	60x60	76,23
000-132	Laminato	70x70	88,94
000-133	Laminato	80x80	101,64
000-137	Laminato	90x90	114,35
000-134	Laminato	80x120	133,41
000-135	Laminato	80x140	152,46

## PIANO LAMINATO: SPESSORE 22 MM - BORDO TORO/PIATTO/ABS A LIBRO/ALLUNGA

Codice	Caratteristiche	Misure (cm)	Euro
000-133 LIBRO	a Libro - Laminato	80X80 (APERTO 80x160)	337,95
000-137 LIBRO	a Libro - Laminato	90X90 (APERTO 90x180)	379,89
000-134 ALLUNGA	Laminato con ALLUNGA (cm 42x80)	Piano 80X120 + ALLUNGA = 80x160	292,22

## PIANO: LAMINATO SPESSORE 20 MM BORDO GOMMA TORO/PIATTO/ABS

Codice	Caratteristiche	Misure (cm)	Euro
000-161	Laminato	60X60	74,80
000-162	Laminato	70X70	99,00
000-163	Laminato	80X80	114,40
000-166	Laminato	80X120	140,80
000-168	Laminato	80X180	248,60
000-084	Laminato	45X70	71,50

## PIANO: VETRO TEMPERATO TRASPARENTE - ACIDATI/SOLO FASCIA/COLORATI

Codice	Caratteristiche	Misure (cm)	Euro
000-190	Temperato - Acidato	70x70	147,40
000-180 SAT	Temperato - Acidato	80x120	258,50

ALTRE MISURE SOLO SU RICHIESTA

## PIANO: MULTISTRATO PIOPPO GREZZO SPESSORE 20 MM - BORDO GOMMA TORO/PIATTO

Codice	Caratteristiche	Misure (cm)	Euro	
			Senza bordo	Con bordo
000-364	Multistrato Pioppo	Ø 100	148,50	168,30
000-366	Multistrato Pioppo	Ø 120	152,90	187,00
000-367	Multistrato Pioppo	Ø 140	192,50	222,20
000-368	Multistrato Pioppo	Ø 160	202,40	242,00
000-369	Multistrato Pioppo	Ø 180	210,10	260,70
000-370	Multistrato Pioppo	80x80	61,60	83,60
000-371	Multistrato Pioppo	90x90	77,00	100,10
000-372	Multistrato Pioppo	80/90x120	77,00	110,00
000-373	Multistrato Pioppo	80x150/160	99,00	137,50
000-374	Multistrato Pioppo	80x180	106,70	143,00
000-374-B	Multistrato Pioppo	80x200	134,20	178,20
000-375	Multistrato Pioppo	80x240	143,00	188,10

### SOVRAPPREZZO

Spessore 25 mm	+15%	+15%
Applicazione listelli di sovrapposizione piani [80x80 e 90x90]	44,00	44,00

### SOVRAPPREZZI

	+ Euro
CROMATURA 000-CROM STRESA, TURBO, DORIA, LAURETTA TELAIO CROMATO	11,44
CROMATURA SGABELLI E SEDIE JESSICA E BISTROT	49,50
CROMATURA BASI TAVOLI JOKER, A, JOKER 4 GAMBE	66,00
CROMATURA EXTRABARA Ø 46 (BASE E STELO) E ARGENTARIO 1 PER PIANI 80X80	44,00
VERNICIATURA COLORI FUORI SERIE SEDIE E POLTRONE, TAVOLI DAL CODICE (5) AL (22) - GIÀ CALCOLATO (Euro 6,99)	vedi seconda colonna prezzi
VERNICIATURA COLORI FUORI SERIE SEDIE E POLTRONE, TAVOLI per colore CROMO LUCIDO/OPACO/SATINATO - GIÀ CALCOLATO (Euro 11,18)	vedi terza colonna prezzi

# COLORI VERNICI IN POLVERE

## COLORI DI SERIE



Nero Satinato (1)



Rosso RAL 3000 (2)



Marrone (3)

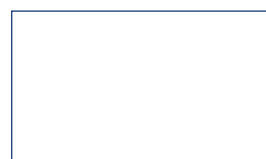

Bianco (4)

## COLORI FUORI SERIE



Blu Elettrico (5)



Alluminio su ferro lucido (6)



Bordeaux (7)

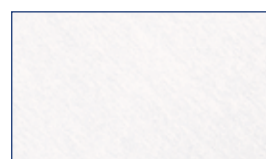

Ossidato (8)

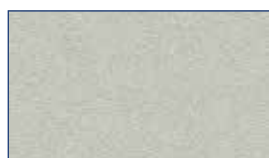

Grigio Grinzato opaco (9)



Giallo (10)



Grigio Ral 7031 (11)



Canna di Fucile (12)



Martellato Grigio (13)



Antracite (24)



Verde Sequoia Ral (16)



Nero Goffrato (19)



Dorato opaco (20)



Ramato (21)



Nero Grinzato (22)

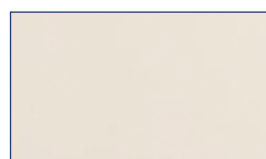

Panna/Crema (25)



Trasparente Lucido (26)  
su struttura grezza



Trasparente Opaco (27)  
su struttura grezza

## COLORI METALLIZZATI CROMO

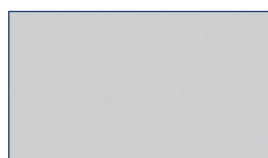

Cromo Lucido  
(23 LUC)

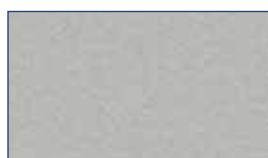

Cromo Satinato  
(23 SAT)

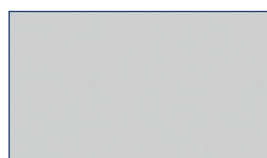

Cromo Opaco  
(23 OP)

## FINTA PELLE (SKAY) NORMALE



(30) Nero 991



(31) Bordeaux 502



(32) Nocciola 102

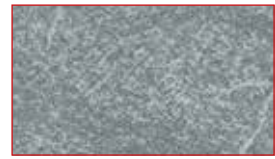

(33) Grigio Venato



Marrone Venato 259



(36) Grigio Topo



Verde Scuro 801



(37) Blu 902



(37) Blu 904



(39) Rosso 501



(40) Cuoio 206

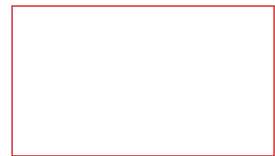

(41) Bianco

## TESSUTI NORMALI CATEGORIA A



Angel - 30 Arancio



Angel - 35 Rosso



Angel - 57 Nero



Dama 60



Dama 01

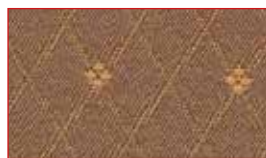

Dama 04



Dama 10



Dama 50

# TESSUTI E RIVESTIMENTI

## TESSUTI SERIE UFFICO (NORMALI E IGNIFUGHI)

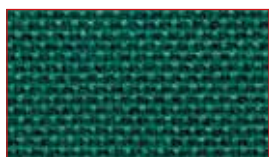

Verde 18 - N  
Verde 18 - I



Blu 16 - N  
Blu 16 - I



Rosso 27 - N  
Rosso 27 - I

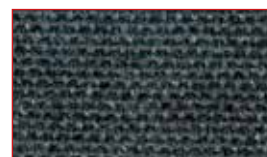

Antracite 32 - N  
Antracite 32 - I Nero

## TESSUTO IGNIFUGO



Bordeaux



Verde



Blu chiaro



Rosso

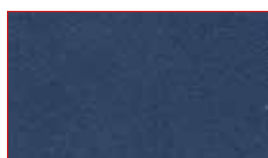

Blu scuro

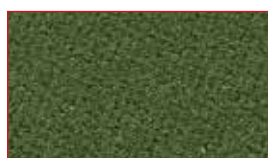

Verde scuro



Nero

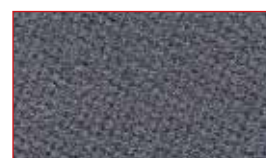

Grigio

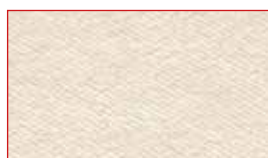

Panna



Nocciola



Arancio



Verde Chiaro

LA MICROFIBRA IGNIFUGA È FORNITA CON LE STESE TONALITÀ DI COLORE DEL TESSUTO IGNIFUGO

## FINTA PELLE (SKAY) IGNIFUGA

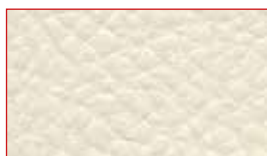

Panna 11549



Rosso 9290



Giallo 9315



Grigio 9327



Blu 9806



Bordeaux 9272



Verde 11101



Arancio 9715

## COLORI WERZALIT



18W Ciliegio



31W Wengè



39W Noce Noyer Bois



42W Palissade Bois



43W Kbana Rouge



44W Kbana Taupe



41W Avorio/Seringa



24W Alu (Solo Alu)



41W Bounty



4W Bianco (Solo Blanc)



25W Travertino (SoloTravertin)



22W Marmo Bianco (Marb Genes)



37W Antracite



40W Verdino (Cromy Vert)

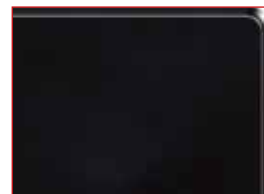

33W Nero (Cromy Noir)



29W Arancio (Cromy Orange)



34W Rosso (Cromy Rouge)



45W (Palissade Blanc)

**PIANI INOX**  
(NON IDONEI PER ESTERNI)

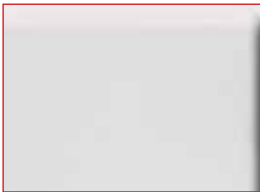

Inox Satinato



Inox Fiorettato

## COLORI LAMINATI



42 Nuovo Noce Tanzania



43 Nuovo Teak Opaco



P01 Faggio naturale



0509 Nero



0561 Rosso



0564 Giallo



0566 Blu



0570 Verde

# COLORI PIANI

## COLORI NOBILITATI

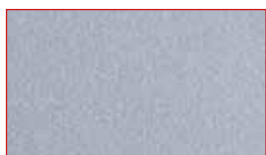

Grigio metallizzato  
(sp.18-25 normale)

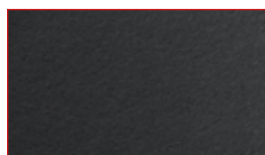

Antracite  
(sp.18-25 normale)

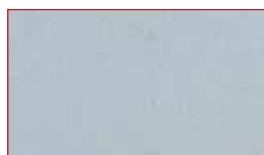

Grigio 1365  
(sp.18-25 idrofugo)

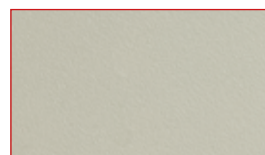

Avorio  
(sp.18-25 normale)

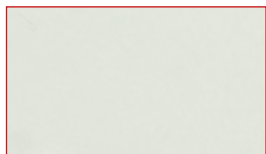

Magnolia  
(sp.18-25 normale)



Blu 90  
(sp.18 normale)

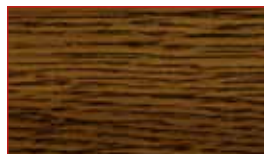

Rovere  
(sp.18 normale)



Rovere chiaro  
(sp.18 normale)

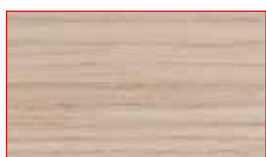

Rovere sbiancato  
(sp.18-25 normale)



Acero  
(sp.18-25 normale)



Noce scuro  
(sp.18-25 idrofugo)



Noce chiaro  
(sp.18-25 normale)



Faggio naturale  
(sp.18-25 normale)



Ciliegio  
(sp.18 normale)

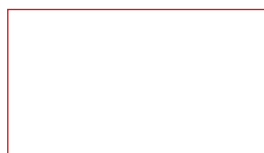

Bianco  
(sp.18-25 idrofugo)



Wengè  
(sp.18-25 normale Ruvido)



Vintage  
(sp.18-25 normale  
CON SOVRAPPREZZO 30%)

## VETRO TEMPERATO

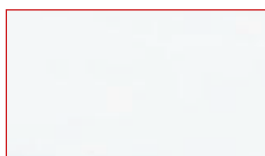

Trasparente

Satinato

## MULTISTRATO PIOPPO



30 Con impregnante



0 Grezzo

## BORDI PIANI



Bordo ABS Alluminio met.



Bordo ABS ciliegio



Bordo Abs millerighe



Multistrato Pioppo grezzo



Laminato stratificato HPL



Bordo Gomma Toro nero



# TIPI DI SEDUTE

 <p><b>452</b> Finta paglia a scatto Ø40 cm  <b>442-F</b> Finta paglia vite            Colori: nero, marrone, rosso e bianco  <b>444IGN</b> Finta paglia scatto ign.            Colore anello: nero  <b>453</b> Finta paglia scatto Ø35 cm            Colore anello: nero</p>	 <p><b>TEX PLAST</b>            Tex Plast            Colori anello: nero, dorato, grigio metallizzato, bianco, marrone, rosso            Colore seduta: grigio</p>	 <p><b>452/S.AN</b>            Senza anello. Forato a scatto Ø40 cm            Colori: bianco, nero, verde 6005, blu 5003, alluminio metallizzato            Anello opzionale alluminio metallizzato</p>	 <p><b>443</b> Vera paglia Ø40 cm            Colore: paglia</p>	 <p><b>000-482, 482/RET.</b> Coppia sedile e schienale non forato laminato colori: faggio naturale, noce tanzania, Nuovo tek opaco, nero</p>
 <p><b>447</b> Trapezio finta paglia Ø40 cm  <b>447IGN</b>            Colore anello: nero</p>	 <p><b>446</b> Rigato a scatto            Colore: nero</p>	 <p><b>447</b> Paglia forato trapezio  <b>447IGN</b> Colori: nero, paglia, bianco, verde 6005, blu 5003</p>	 <p><b>509</b> Impero - Cicala            Colore anello = struttura</p>	 <p><b>478</b> Faggio Trapezio - Milano            Colore: naturale</p>
 <p><b>476</b> Faggio multistrato Ø40 cm spessore 16 mm            Colore: naturale P01</p>	 <p><b>476</b> Faggio multistrato Ø40 cm spessore 16 mm            Colore: ciliegio P87</p>	 <p><b>476</b> Faggio multistrato Ø40 cm spessore 16 mm            Colore: noce chiaro P21</p>	 <p><b>476</b> Faggio multistrato Ø40 cm spessore 16 mm            Colore: noce scuro P97</p>	 <p><b>476</b> Faggio multistrato Ø40 cm spessore 16 mm            Colore: wengé P128</p>
 <p><b>476</b> Faggio multistrato Ø40 cm spessore 16 mm            Colore: rovere grigio P04</p>	 <p><b>476</b> Faggio multistrato Ø40 cm spessore 16 mm            Colore: rovere sbiancato P03</p>	 <p><b>461</b> Skay nero Ø40 cm su supporto truciolare (girato) o con anello col. nero, metallizzato, dorato</p>	 <p><b>454</b> Fiore Ø40 a scatto.            Colori: verde 6005, blu 5003, arancio, nero, bianco. Anello opzionale colore: alluminio metal.</p>	 <p><b>401</b> Coppia Sedile e Schienale Porto-bello. Colori: bianco, verde 6005, testa di moro, blu 5003, arancio</p>
 <p><b>CUBO.</b> 36x36 cm spessore 18 mm, finta pelle Skay.            Colore: disponibile in tutti i colori Skay normali e ignifughi.</p>	 <p><b>461/35.</b> Girato senza anello. Finta pelle Skay Ø35 cm imbottito.            Colore: disponibile in tutti i colori Skay normali e ignifughi.</p>	 <p><b>462.</b> Con anello. Finta pelle Skay Ø40 cm. imbottito            Colore: disponibile in tutti i colori Skay normali e ignifughi.            Colori anello: nero, dorato, grigio metallizzato.</p>	 <p><b>462/Ø32.</b> Finta pelle Skay Ø32 cm, spessore 10 cm.            Colore: disponibile in tutti i colori Skay normali e ignifughi..</p>	 <p><b>404.</b> Seduta e schienale imbottito in tessuto serie ufficio.            Colore: disponibile in tutti i colori serie ufficio</p>









Colori disponibili per tutte le scocche

		 <p><b>422</b> Scocca D5 a vite.            Stresa, Turbo, Doria, Selena  <b>427IGN</b></p>	 <p><b>425</b> Scocca 102 scatto.            Turbo, Doria, Selena, Vaticano  <b>430IGN</b></p>	 <p><b>423</b> Scocca D6 a vite.            Stresa, Turbo, Doria, Selena  <b>428IGN</b></p>
				
				







Colori disponibili



	 <p><b>426</b> Sedile e schienale in polipropilene per sedia Novaiso. Sedile avvitato, schienale inserito  <b>426IGN</b></p>
	
	
	

Colori disponibili per scocca PULL

							
Marrone	Nero	Arancio	Viola	Rosso	Bianco	Grigio	Verde

Colori disponibili per scocca S18

					
Marrone	Nero	Arancio	Rosso	Bianco	Verde

 <p><b>PULL</b> Scocca in polipropilene per Cristina sedia, a vite</p>	 <p><b>S18</b> Scocca in polipropilene per S18 sedia, a vite</p>
---	---

## CONDIZIONI GENERALI DI VENDITA

I prezzi si intendono al pubblico, montaggio messa in opera e IVA esclusi. I termini di consegna hanno valore indicativo e non garantiscono il pieno rispetto dei tempi previsti, salvo impegni sottoscritti all'atto dell'ordine, dalla Società.

L'impossibilità di effettuare le forniture per causa di forza maggiore esonerano la TRIMAR Srl da ogni responsabilità e non possono dar luogo ad alcuna rivalsa di danni. Il trasporto sarà effettuato in PORTO FRANCO per ordini di importo superiore a € 1.000,00. Per ordini di importo compreso tra € 500,00 e € 1.000,00 sarà applicato in fattura UN ADDEBITO PARI AL 6%. Per ordini di importo inferiore a € 260,00 la merce si intende franco ns. stabilimento. Per merce ritirata presso la ns. sede da vettore o in proprio dal committente verrà applicato un ulteriore sconto del 5%. Le spese di trasporto per la Sardegna e l'Italia centro-sud sono da concordare.

IN CASO DI RESA CON NOSTRI MEZZI O CON NOSTRI VETTORI LA MERCE SI INTENDE A SPONDA DI CAMION.

La merce viaggia a rischio e pericolo del committente anche a trasporto effettuato in porto franco.

Per la merce spedita con vettori, sarà applicato un contributo spese imballo pari a € 10,00 per ogni € 500,00 di merce al netto di sconto.

Ogni reclamo riguardante la qualità o la quantità della merce spedita dovrà essere notificato per raccomandata o telefax entro e non oltre 8 giorni dal ricevimento della stessa. Trascorso tale termine non saranno ammessi reclami e le fatture s'intenderanno interamente accettate. Non si accettano reclami dopo la messa in opera dei prodotti. Per pagamenti alla consegna verrà effettuato uno sconto del 3%, che viene escluso se consegna mezzo vettore, in tal caso il 3% verrà applicato solo con pagamento con bonifico bancario ad avviso di merce pronta. Diversamente non sono previsti sconti cassa e il pagamento avverrà in due soluzioni, con ricevute a 30/60 giorni, con addebito spese incasso. In caso di ritardato pagamento, salvo i diritti previsti dal Codice Civile a favore del venditore, sarà prevista l'applicazione degli interessi bancari in vigore al momento. I pagamenti devono essere fatti direttamente alla Casa. Per qualsiasi azione o controversia legale il foro competente sarà esclusivamente quello di ALESSANDRIA. Misure e dati contenuti nel presente catalogo sono indicativi.

La TRIMAR si riserva il diritto di apportare modifiche o varianti, senza preavviso, o togliere dalla produzione gli articoli che non corrispondono più alle esigenze di mercato, senza ciò costituisca motivo di rivalsa.

Il presente listino annulla tutti i listini precedenti ed entra in vigore a partire dal 01/03/2015. Tutti i prezzi e le condizioni sono da ritenersi valide, salvo errori e od omissioni.

- I PREZZI SI INTENDONO TACITAMENTE ACCETTATI SE NON CONTESTATI  
NEI TRE GIORNI SUCCESSIVI ALL'INVIO DELLA CONFERMA D'ORDINE

- I TERMINI DI CONSEGNA SONO SEMPRE INDICATIVI E NON VINCOLANTI, NESSUN DANNO DIRETTO O  
INDIRETTO PUÒ ESSERE RICHiesto PER MANCATA O RITARDATA CONSEGNA

- LA TRIMAR SRL NON È RESPONSABILE DEL TRASPORTO, DI EVENTUALI RITARDI O DANNI CAUSATI DALLO STESSO

### PATTO DI RISERVATO DOMINIO

La TRIMAR SRL, in caso di pagamento dilazionato, rilascia la merce in regime di riserva di proprietà  
sino al giorno del saldo completo della fattura da parte del cliente



Via San Rocco 18 - Z.I. D2  
15065 Frugarolo (AL)

Telefono 0131 296712  
Fax 0131 296713

[www.trimaral.com](http://www.trimaral.com)  
[trimar@trimaral.com](mailto:trimar@trimaral.com)

